

MATLAB EXPO 2019

Introduction to 5G PHY

Gerald Albertini

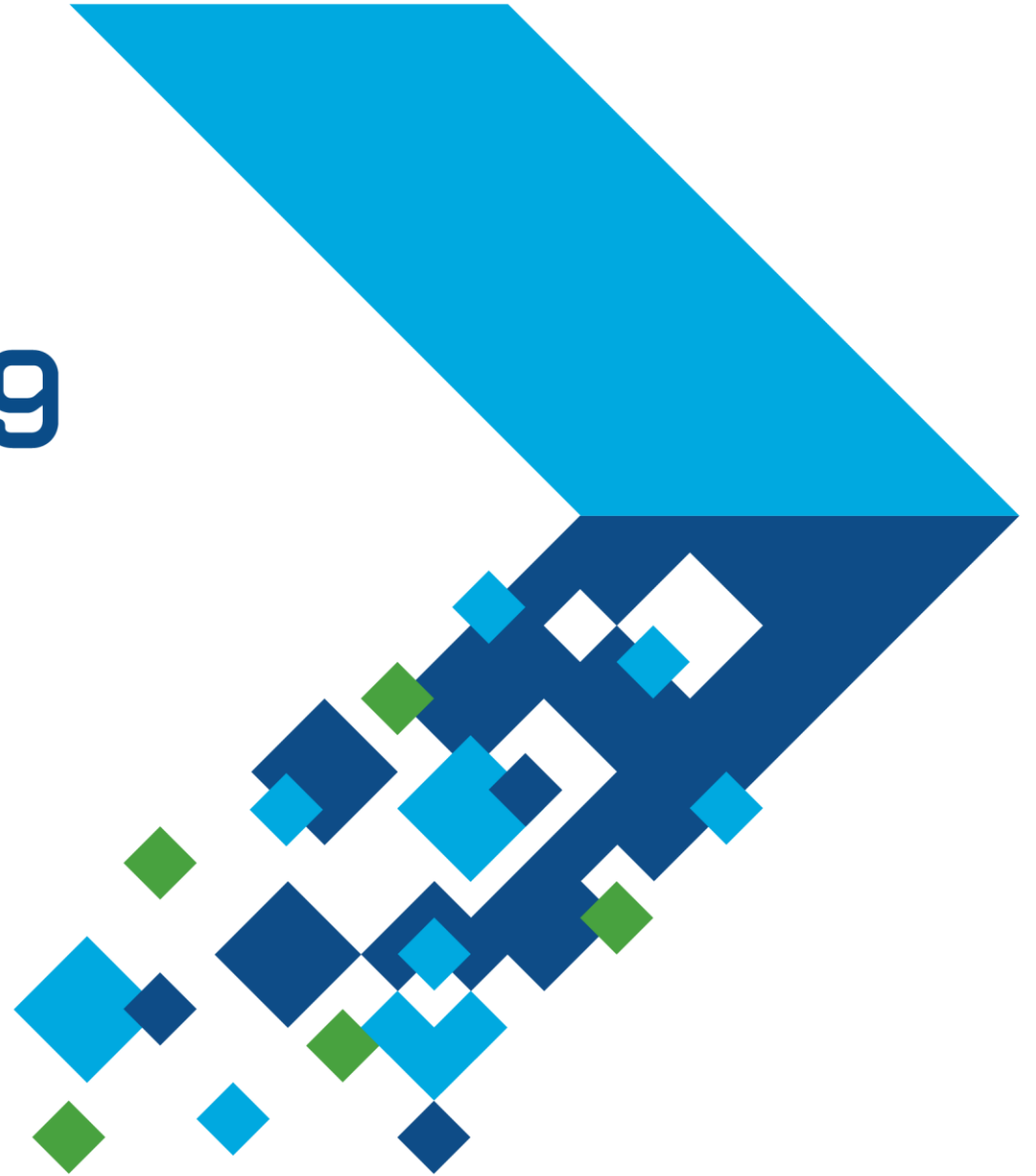

Introduction to 5G Physical Layer

- 5G requirements and use cases
- Key 5G physical layer features
- Physical layer simulation with 5G Toolbox

5G Use Cases and Requirements

- eMBB (enhanced Mobile Broadband)
 - High data rates
 - Increased bandwidth efficiency
- mMTC (massive Machine Type Communications)
 - Large number of connections
 - Energy efficiency and low-power operation
- URLLC (Ultra-Reliable and Low Latency Communications)
 - Low latency

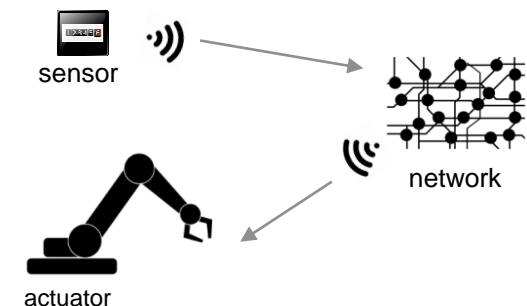

5G vs LTE: Main Physical Layer Differences

	LTE	5G
Use cases	Mobile broadband access (MTC later)	More use cases: eMBB, mMTC, URLLC
Latency	~10 ms	<1 ms
Band	Below 6 GHz	Up to 60 GHz
Bandwidth	Up to 20 MHz	Up to 100 MHz below 6 GHz Up to 400 MHz above 6 GHz
Subcarrier spacing	Fixed	Variable
Freq allocation	UEs need to decode the whole BW	Use of bandwidth parts
“Always on” signals	Used: Cell specific RS, PSS,SSS, PBCH	Avoid always on signals, the only one is the SS block

5G Physical Layer Features

Transport Channels, Physical Channels, and Physical Signals

5G Waveforms, Frame Structure and Numerology

Downlink Data

Uplink Data

Downlink Control

CORESETs

Uplink Control

DMRS

Synchronization Signal Block

Initial Acquisition Procedures: Cell Search & RACH

Signals for Channel Sounding

Hybrid Beamforming

5G Transport Channels, Physical Channels and Physical Signals

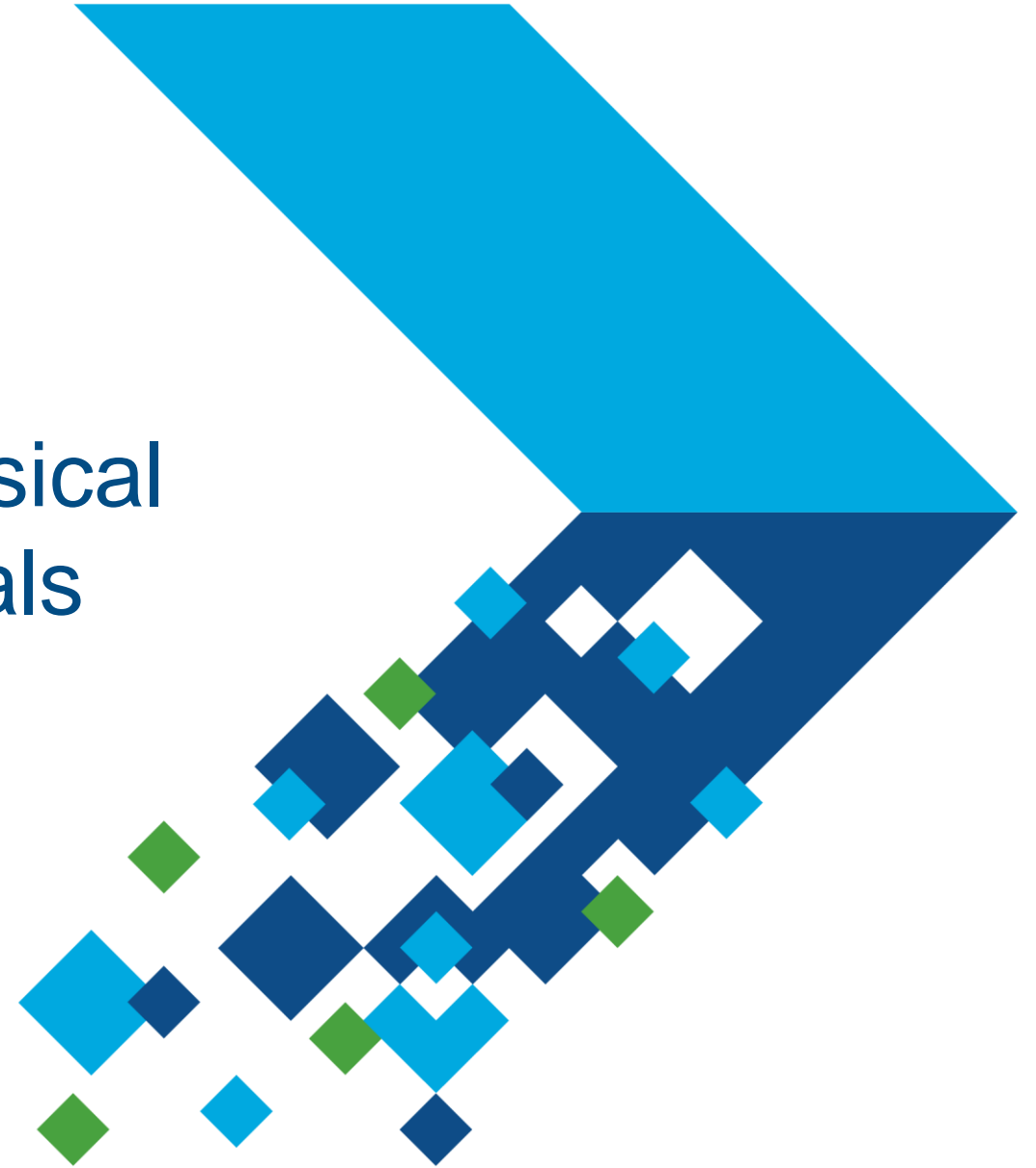

Transport Channels

- Offer information transport services to MAC layer
- Carry control/signalling and data
- Define the scrambling, channel coding, interleaving and rate matching to apply to the information

DL Transport Channels	UL Transport Channels
DL-SCH DL shared channel	UL-SCH UL shared channel
DCI Downlink control information	UCI Uplink control information
BCH Broadcast channel	RACH Random access channel
PCH Paging channel	

Physical layer channels and signals

- Shared, control and broadcast channels
 - Downlink: DL-SCH / PDSCH, PDCCH, BCH / PBCH
 - Uplink: UL-SCH, PUSCH, PUCCH
- Synchronisation and reference signals
 - PSS, SSS, DM-RS

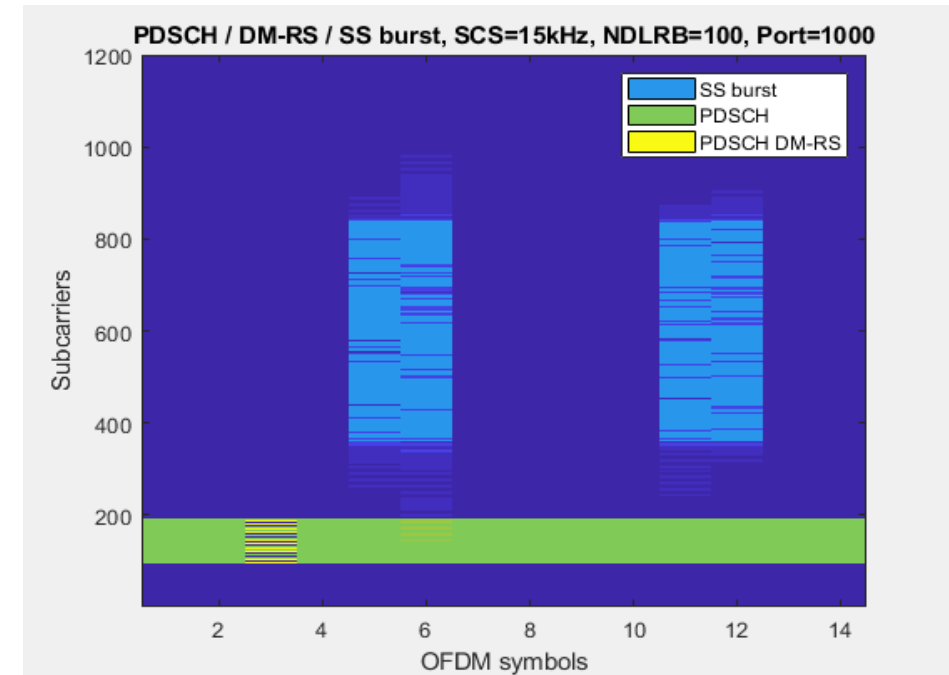
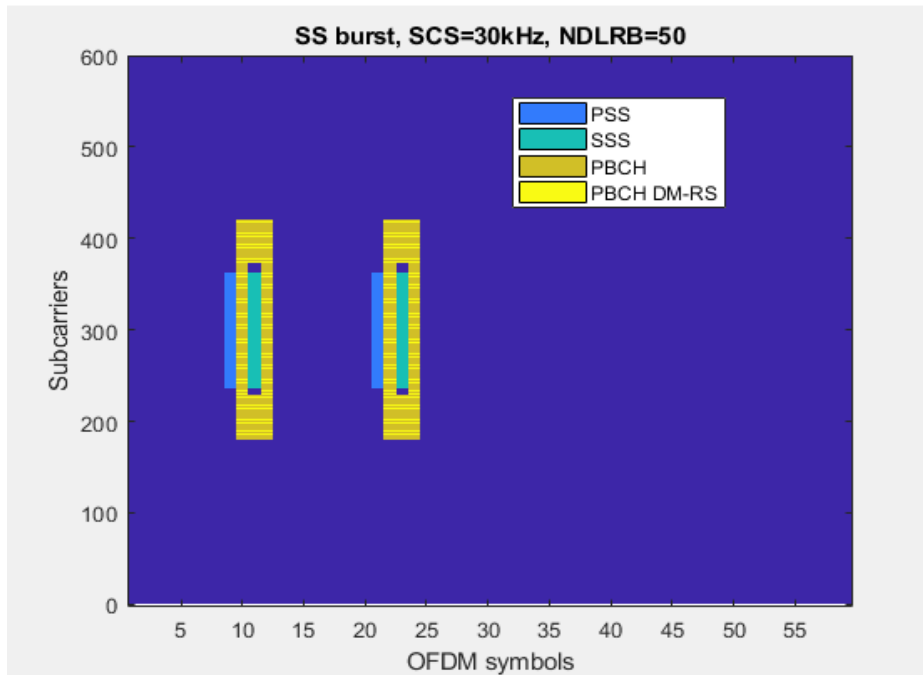
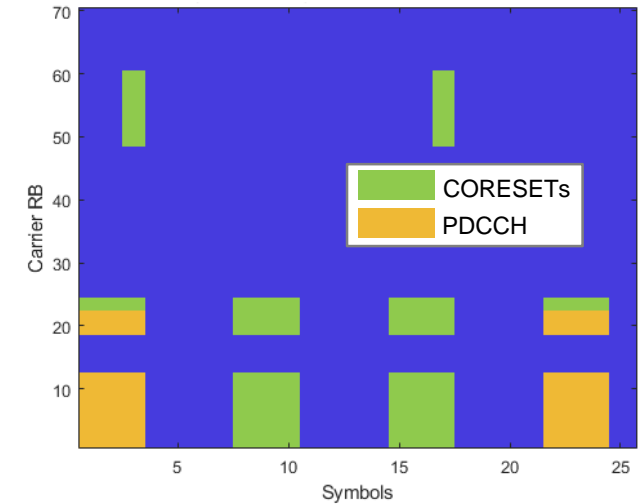

5G Waveforms, Frame Structure and Numerology

- Waveforms
- Resource elements and blocks
- Frame structure
- Variable subcarrier spacing
- Bandwidth parts

Waveforms

- OFDM with cyclic prefix: CP-OFDM
- Increased spectral efficiency with respect to LTE, i.e. no 90% bandwidth occupancy limitation
- Need to control spectral leakage:
 - F-OFDM
 - Windowing
 - WOLA

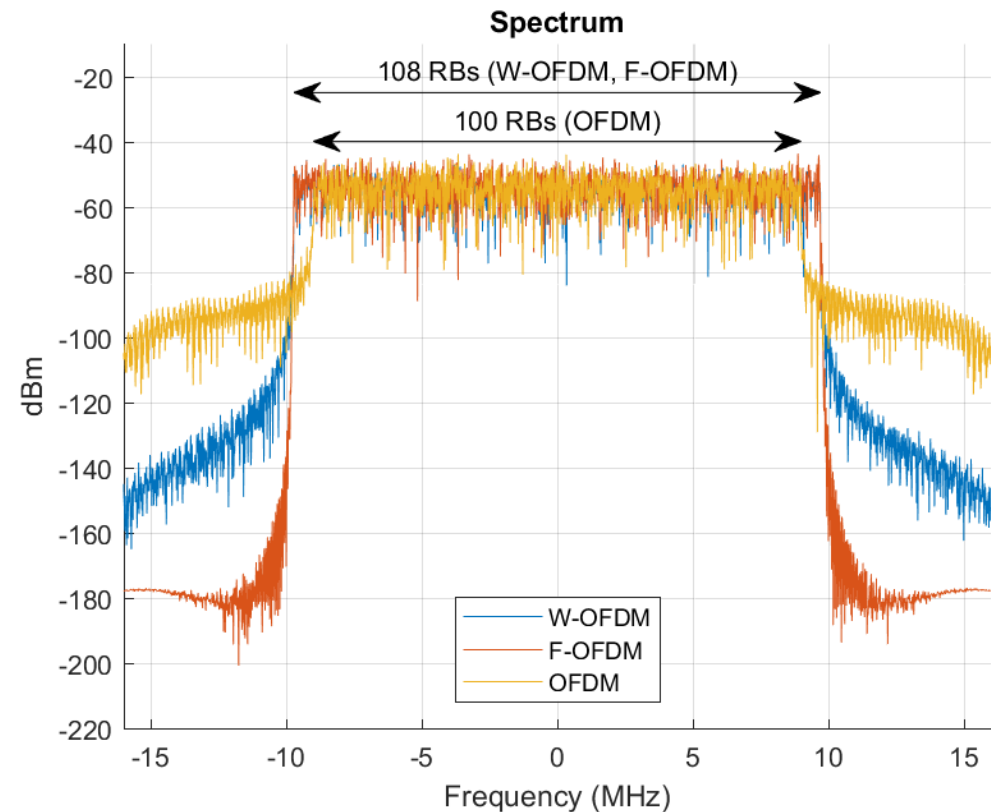

Resource Elements and Resource Blocks

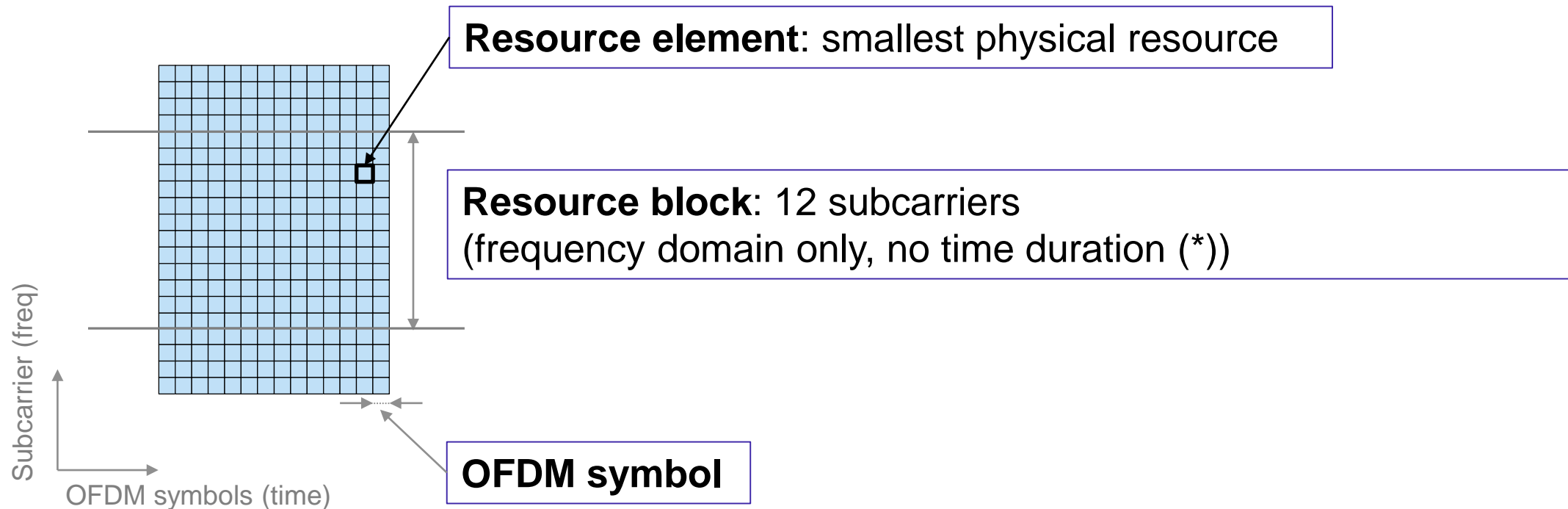

(*) unlike LTE: 1 RB = 12-by-7

Frame Structure

- 10ms frames
- 10 subframes per frame
- Variable number of slots per subframe
- 14 OFDM symbols per slot (normal CP)
- Variable number of OFDM symbols per subframe (different from LTE)

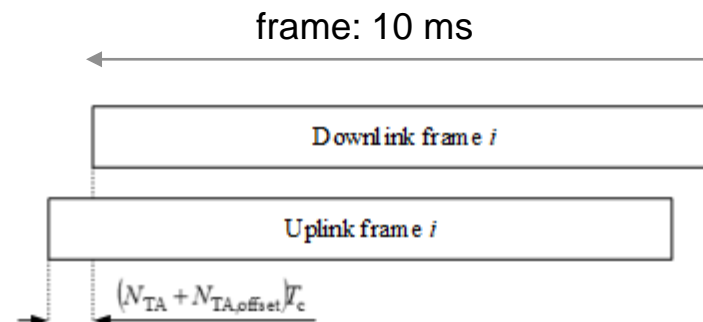

Variable Subcarrier Spacing

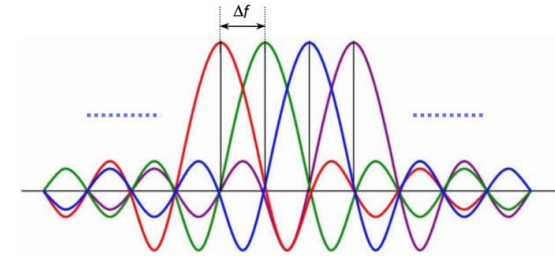

	Slot configuration 0				
Subcarrier spacing (kHz)	15	30	60	120	240
Symbol duration (no CP) (μ s)	66.7	33.3	16.6	8.33	4.17
Nominal max BW (MHz)	49.5	99	198	396	397.4
Min scheduling interval (ms)	1	0.5	0.25	0.125	0.0625

- Subcarrier spacing can be a power-of-two multiple of 15kHz
- Waveforms can contain a **mix of subcarrier spacings**
- Addresses the following issues
 - Support different services (eMBB, mMTC, URLLC) and to meet short latency requirements
 - Increased subcarrier spacing can also help operation in mmWave frequencies

Slots and OFDM Symbols (Normal CP)

Subcarrier spacing (kHz)	Symbols/slot	Slots/frame	Slots/subframe
15	14	10	1
30	14	20	2
60	14	40	4
120	14	80	8
240	14	160	16

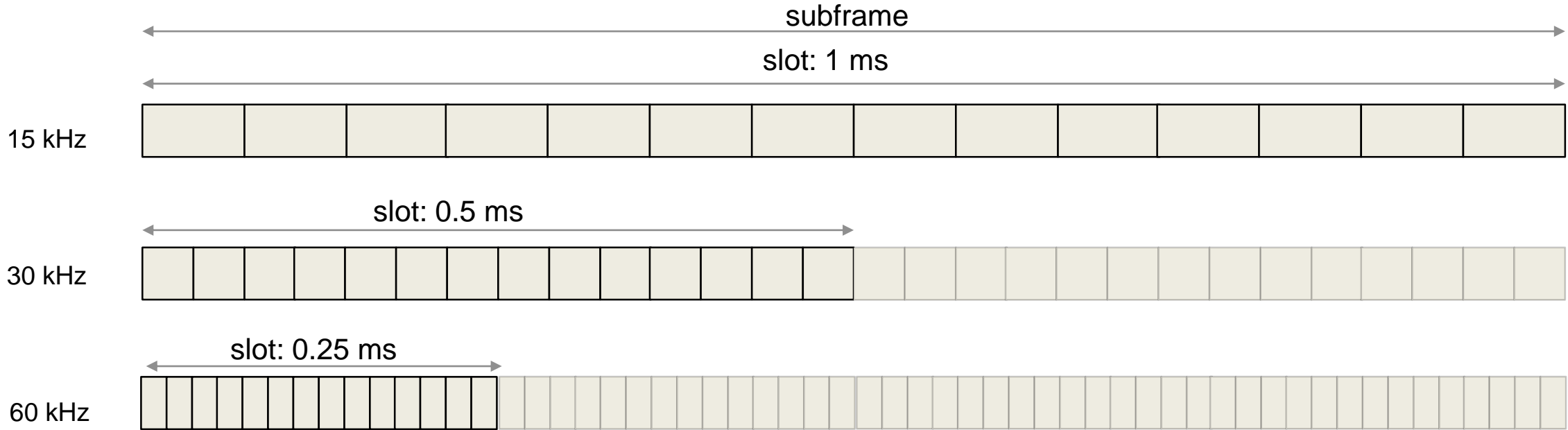

Bandwidth Parts (BWP)

- Carrier bandwidth divided into BWPs
- A BWP is characterized by
 - Subcarrier spacing
 - Cyclic prefix
- Addresses the following issues:
 - Some devices may not be able to receive the full BW
 - Bandwidth adaptation: reduce energy consumption when only narrow bandwidth is required

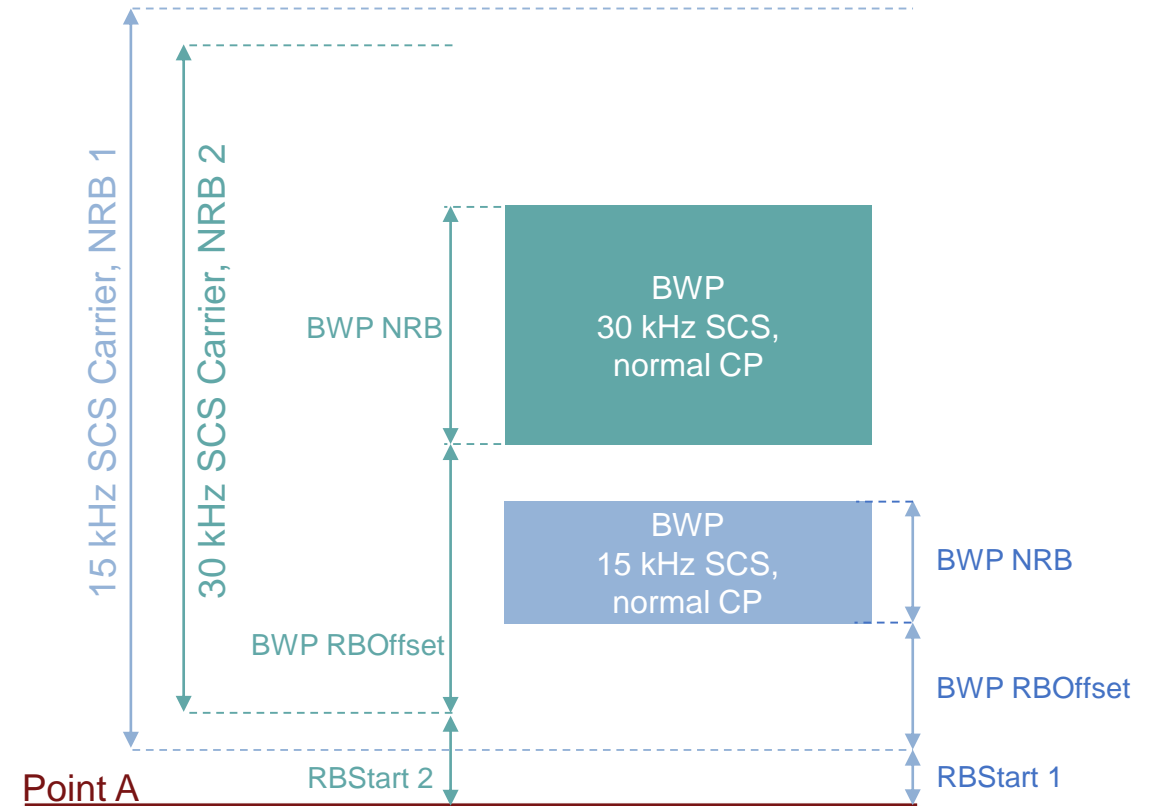

Bandwidth Parts (BWP)

- A UE can be configured with up to 4 bandwidth parts
- Only one bandwidth part is active at a time
- UE is not expected to receive data outside of active bandwidth part

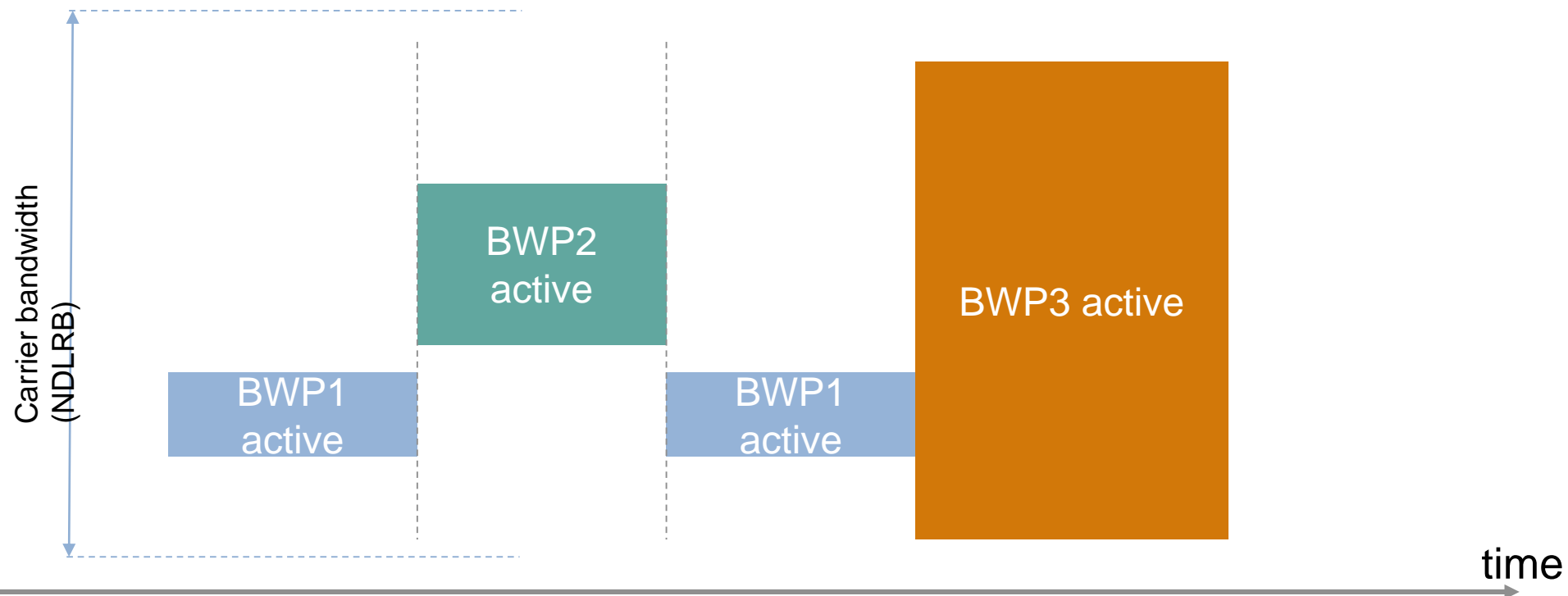

Downlink Data in 5G NR

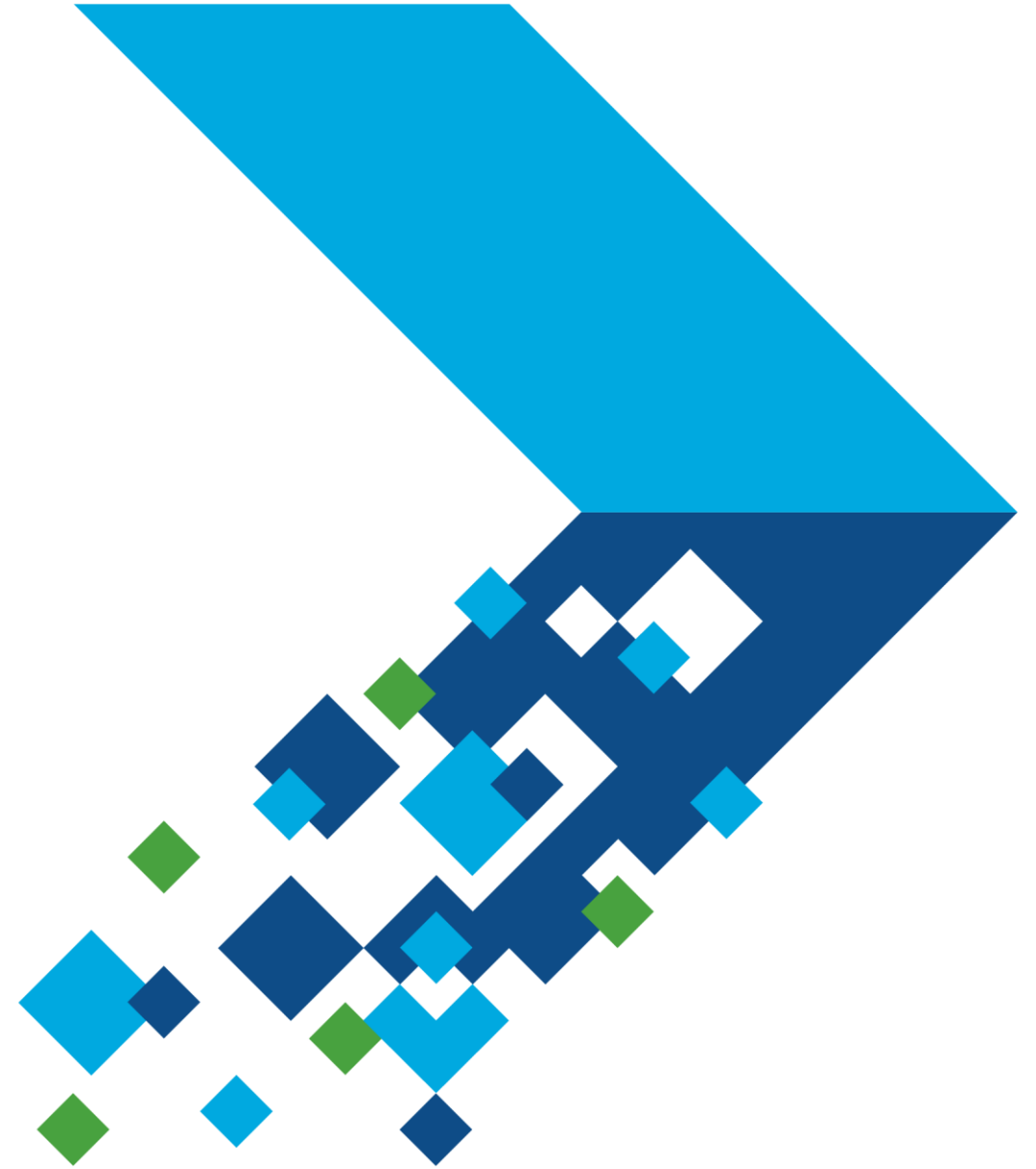

Downlink Shared Channel (DL-SCH)

- Carries user data
- Can also carry the System Information Block (SIB)
- Up to 2 codewords and 8 layers
- Mapped to the PDSCH
- Main difference with LTE: use of LDPC coding

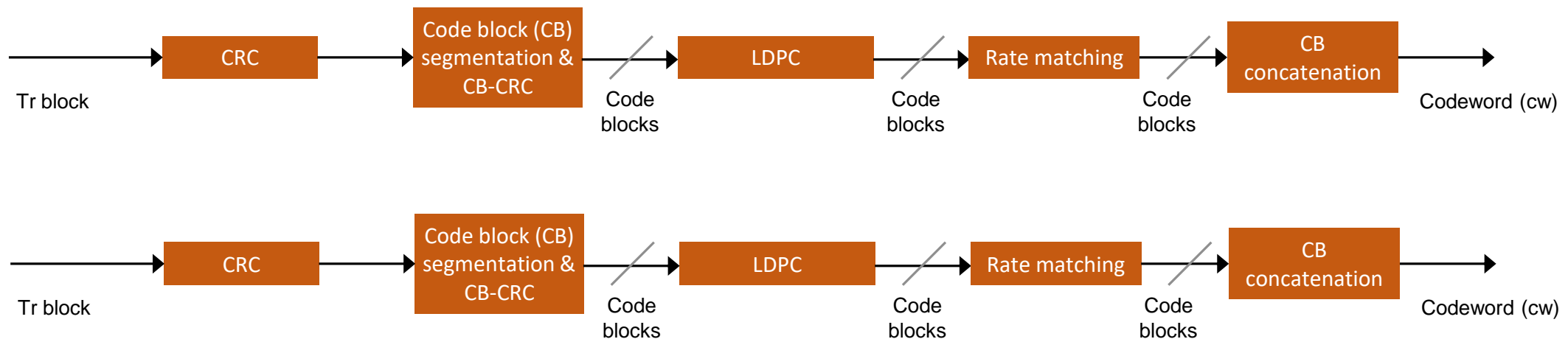

Physical Downlink Shared Channel (PDSCH)

- Highly configurable
- Parameters are configured by:
 - DCI (Downlink Control Information)
 - RRC (Radio Resource Control)

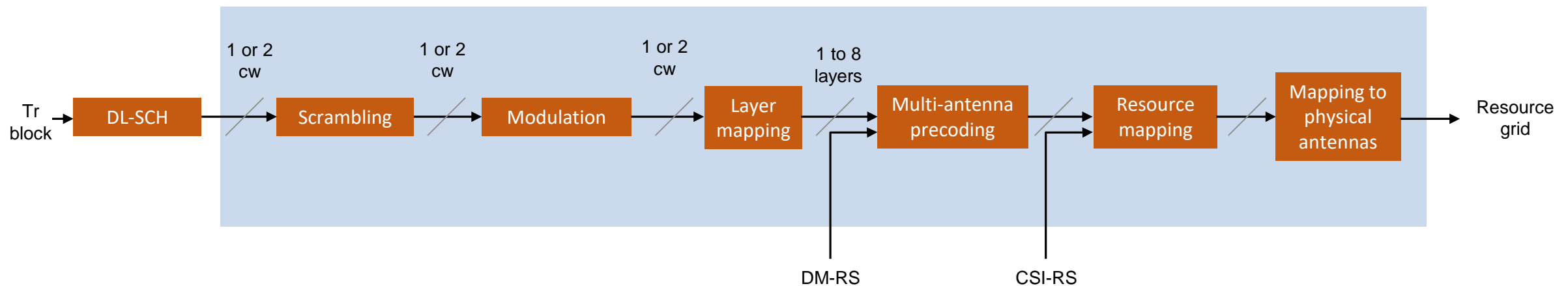

PDSCH Modulation Schemes

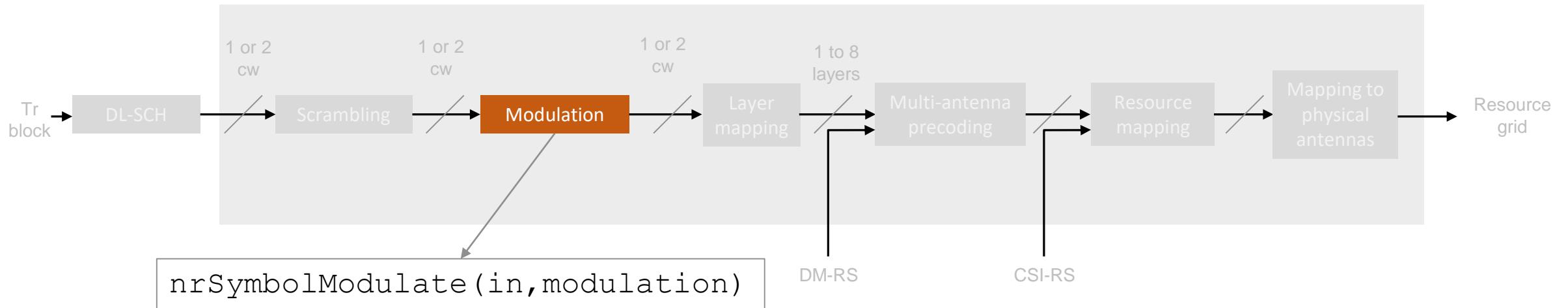

Modulation scheme	Modulation order
QPSK	2
16QAM	4
64QAM	6
256QAM	8

PDSCH Multi-antenna Precoding

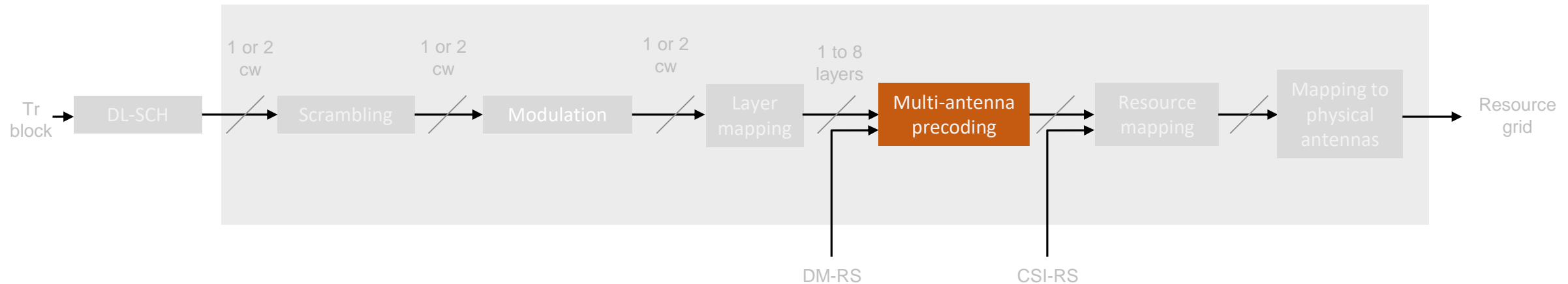

- Achieves beamforming and spatial multiplexing
- Maps layers to antenna port
- Uses a precoding matrix $\mathbf{W}_{N_{\text{antennas}} \times N_{\text{layers}}}$
- DM-RS has to go through the same precoding operation

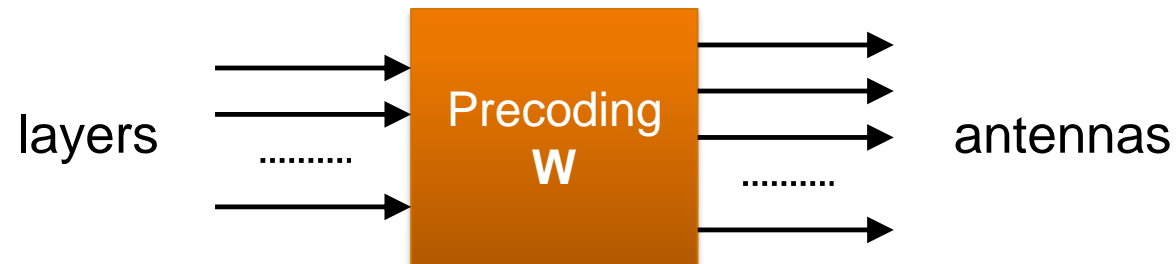

Mapping to Physical Resources

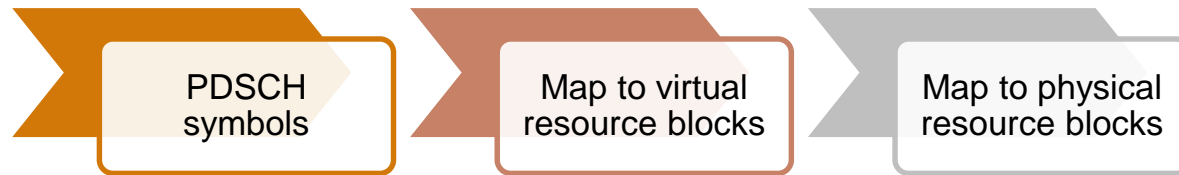
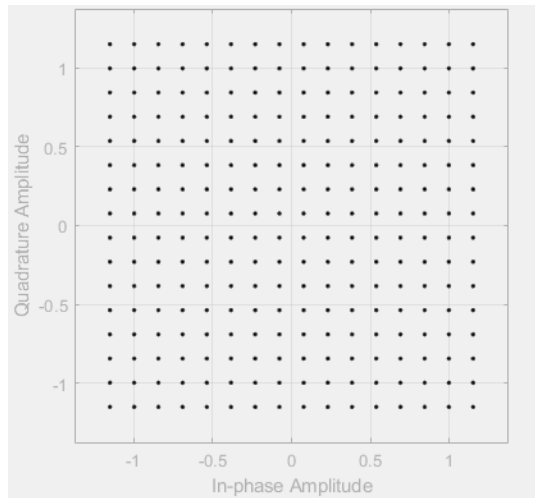
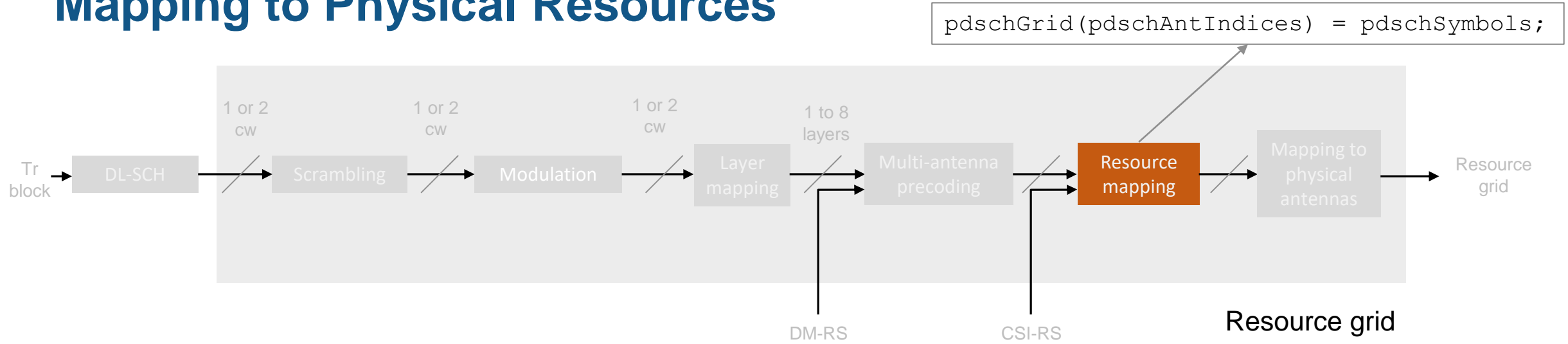

Resource grid

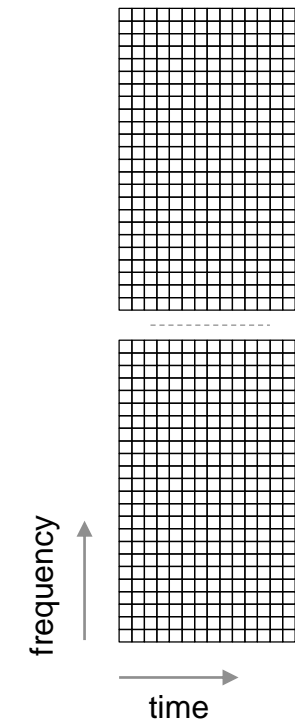

PDSCH Allocation Example

- Can use a full slot or part of a slot
- Partial slot allocation: good for low latency applications

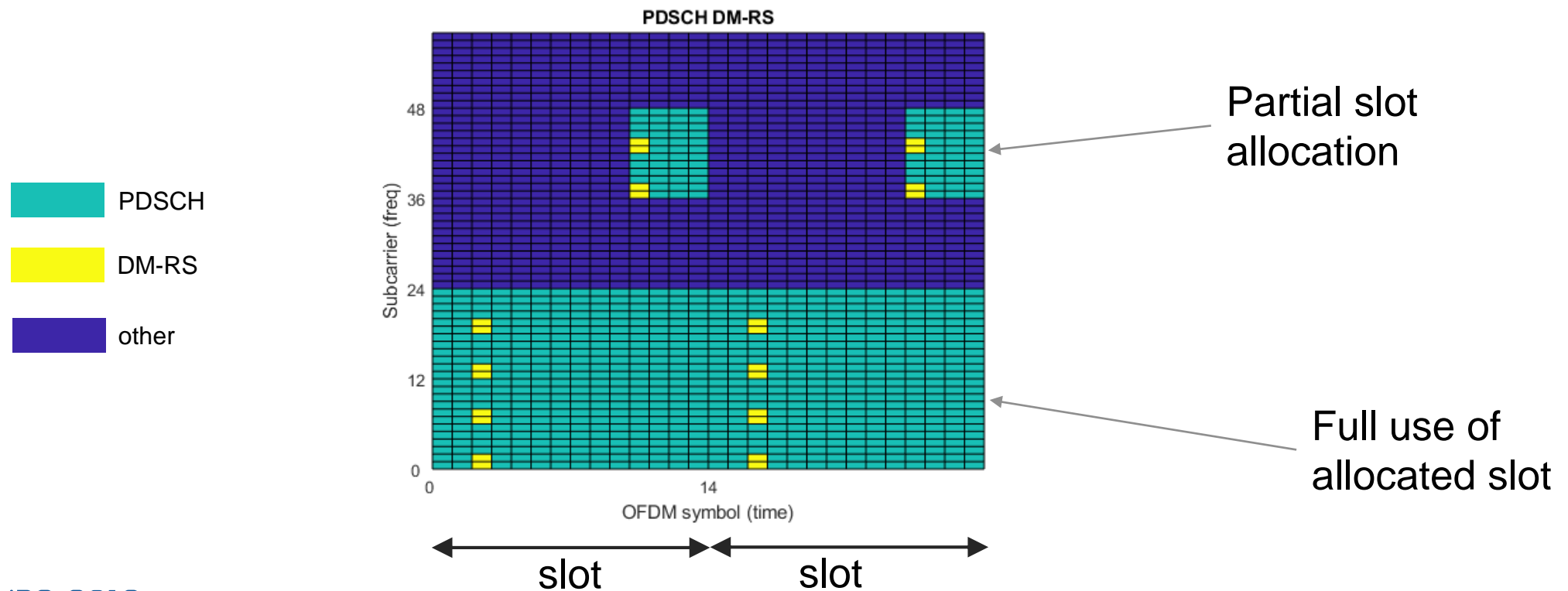

Introducing 5G Toolbox

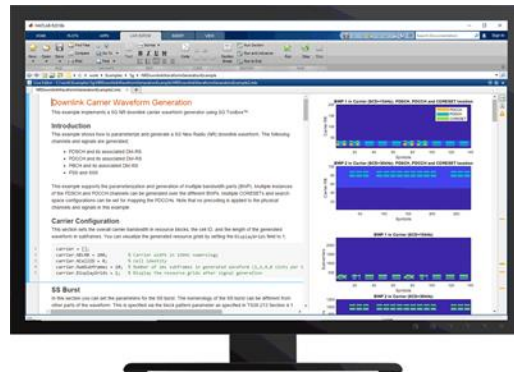

5G Toolbox applications & use cases

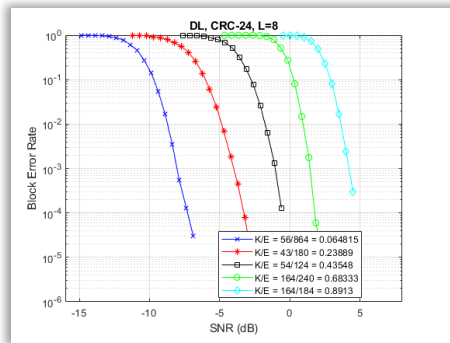

End-to-end link-level simulation

- Transmitter, channel model, and receiver
- Analyze bit error rate (BER), and throughput

Waveform generation and analysis

- Parameterizable waveforms with New Radio (NR) subcarrier spacings and frame numerologies

Golden reference design verification

- Customizable and editable algorithms as golden reference for implementation

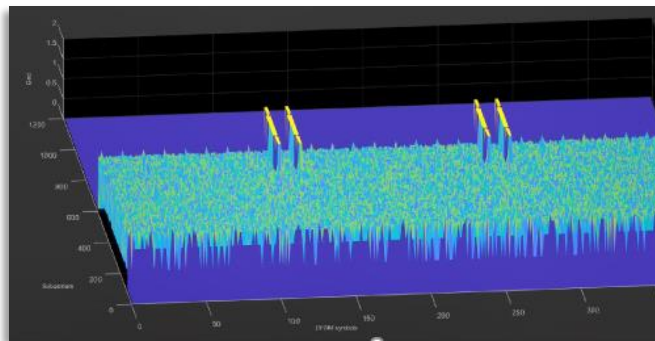

5G Toolbox – PHY Layer Functions

NR Processing Subsystems

- LPDC & polar coding
- CRC, segmentation, rate matching
- Scrambling, modulation, precoding

NR Downlink and Uplink Channels and Physical Signals

- Synch & broadcast signals
- DL-SCH & PDSCH channels
- DCI & PDCCH channels
- UCI, PUSCH, and PUCCH channels

MIMO Prop channels

- TDL & CDL channel models

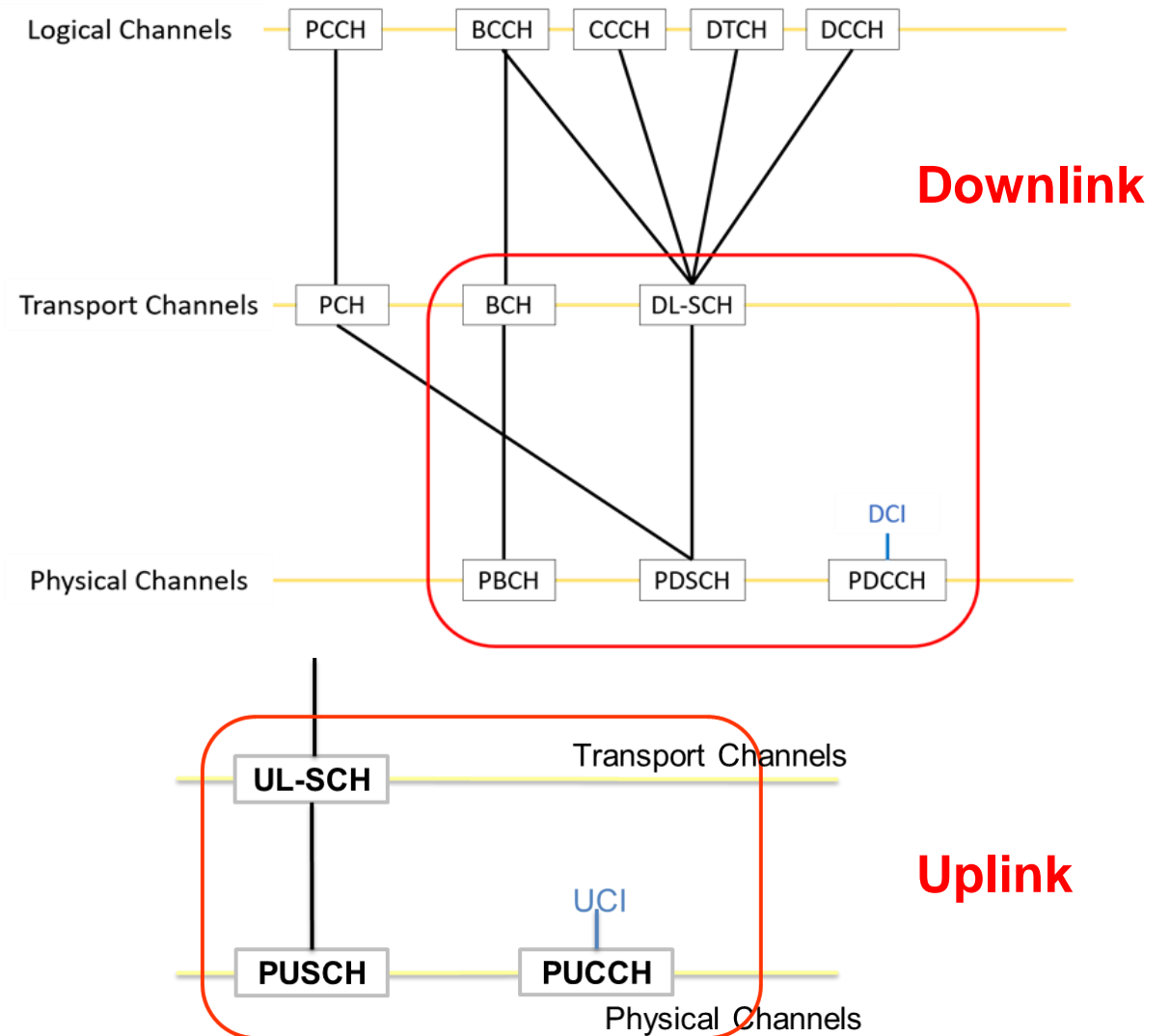

5G Toolbox has open customizable algorithms

- All functions are open, editable, customizable MATLAB code
- C/C++ code generation: Supported with MATLAB Coder

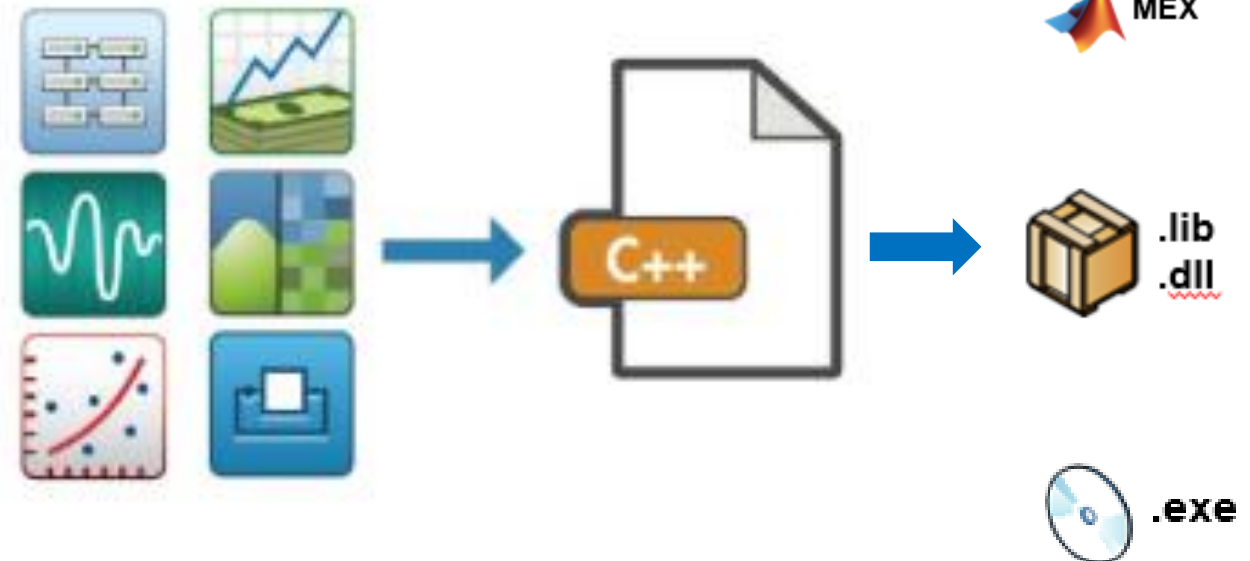
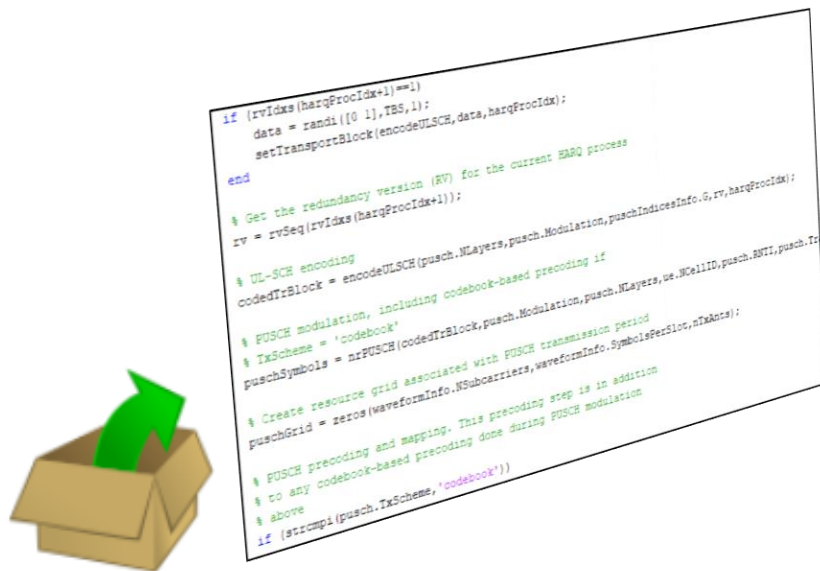

Key Reference Application Examples

- **NR Synchronization Procedures**

- **Downlink:**
 - NR PDSCH BLER and Throughput Simulation
 - NR Downlink Waveform Generation

- **Uplink:**
 - NR PUSCH BLER and Throughput Simulation
 - NR Uplink Waveform Generation

5G NR Uplink Carrier Waveform Generation

This example implements a 5G NR uplink carrier waveform generator using 5G Toolbox(TM).

Copyright 2018 The MathWorks, Inc.

Introduction

This example shows how to parameterize and generate a 5G New Radio (NR) uplink waveform. The following channels and signals are generated:

- * PUSCH and its associated DM-RS
- * PUCCH and its associated DM-RS

This example supports the parameterization and generation of multiple bandwidth parts (BWP). Multiple instances of the PUSCH and PUCCH channels can be generated over the different BWPs.

Carrier Configuration

This section sets the overall carrier bandwidth in resource blocks, the cell ID, and the length of the generated waveform in subframes. You can visualize the generated resource grids by setting the `DisplayGrids` field to 1.

```
carrier = [];
carrier.NULRB = 200; % Carrier width in 15kHz numerology
carrier.NCellID = 0; % Cell identity
carrier.NumSubframes = 10; % Number of 1ms subframes in generated waveform (1,2,4,8 slots per 1m
carrier.DisplayGrids = 1; % Display the resource grids after signal generation
```

