

MATLAB EXPO 2017

How to build an **autonomous** anything

Mary Ann Freeman
Director of Engineering,
MATLAB Products, Deep Learning, Data Analytics
MathWorks

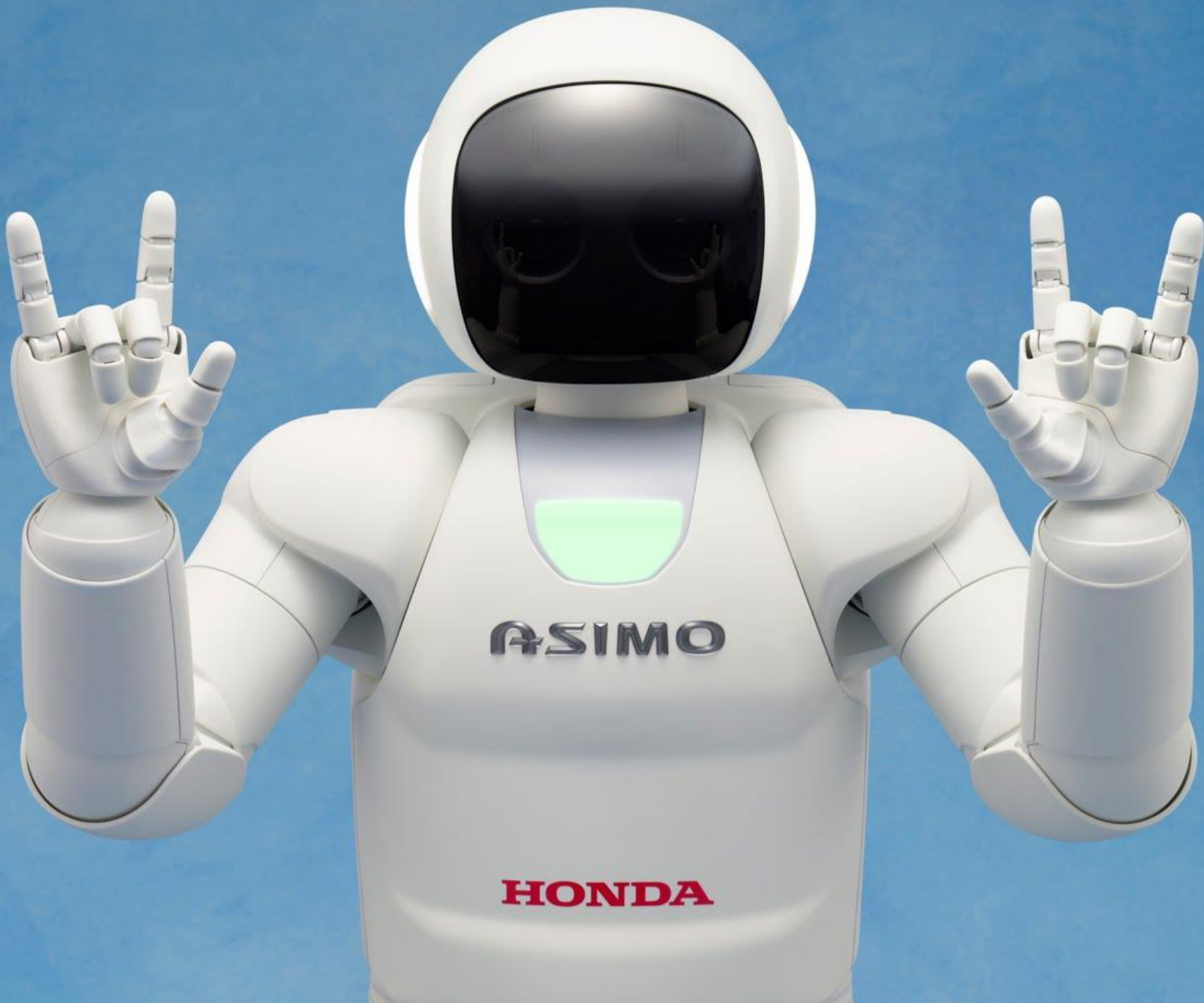









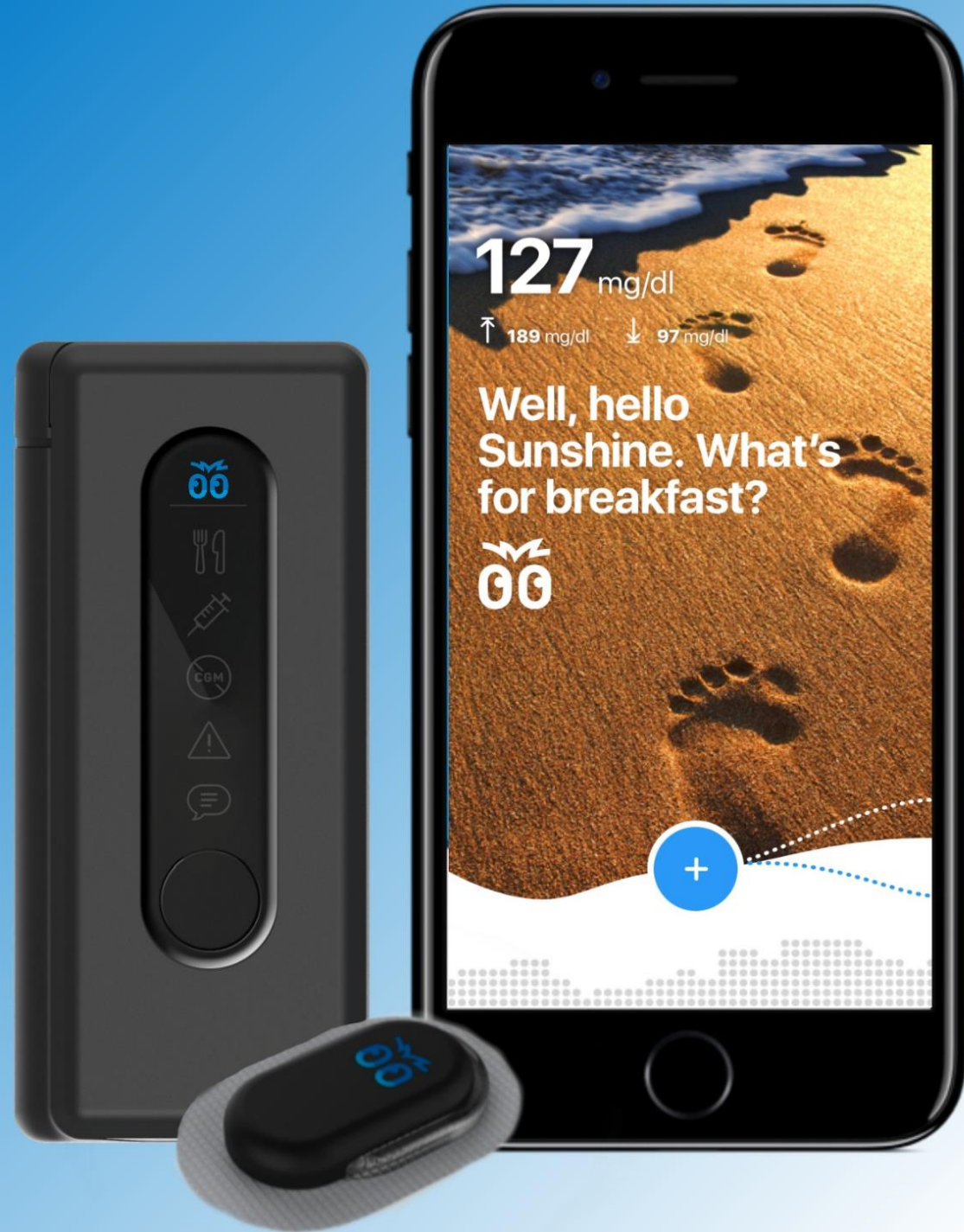

127 mg/dl

↑ 189 mg/dl ↓ 97 mg/dl

Well, hello
Sunshine. What's
for breakfast?

00



Autonomous Technology

Autonomous

Acting independently

Autonomous Technology

Autonomous Technology

*Provides the ability of a system to act **independently** of direct human control*

Autonomous Technology

*Provides the ability of a system to act **independently** of direct human control under **unrehearsed** conditions*



Capabilities of an Autonomous System



Capabilities of an Autonomous System

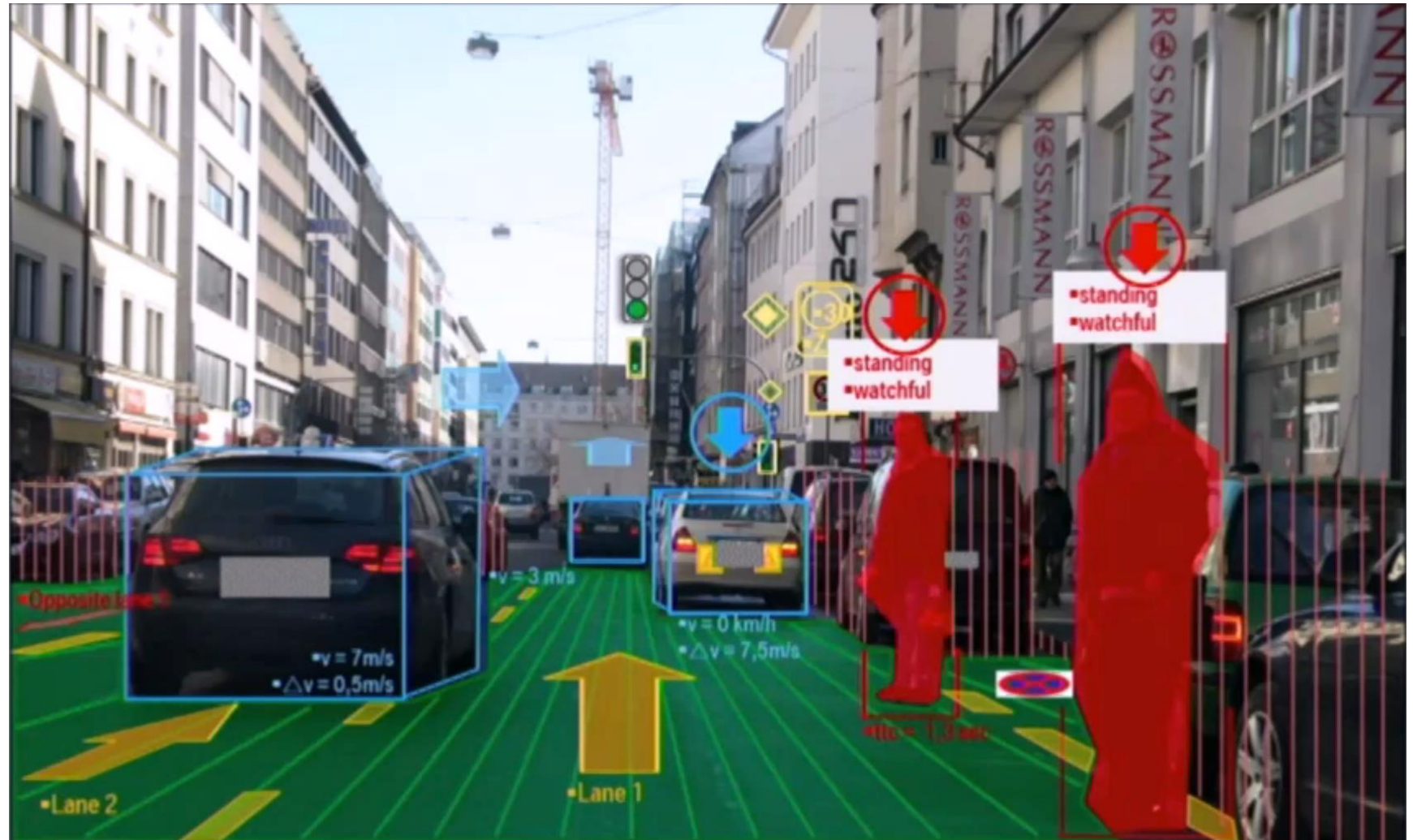
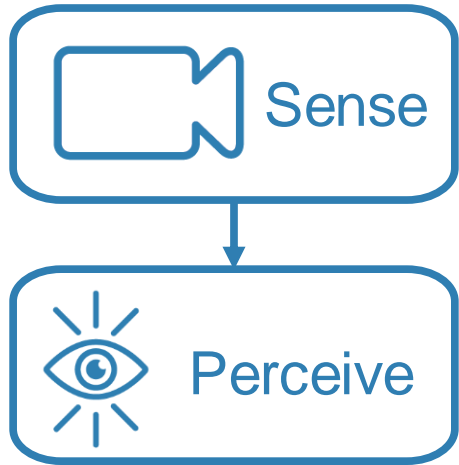

Capabilities of an Autonomous System

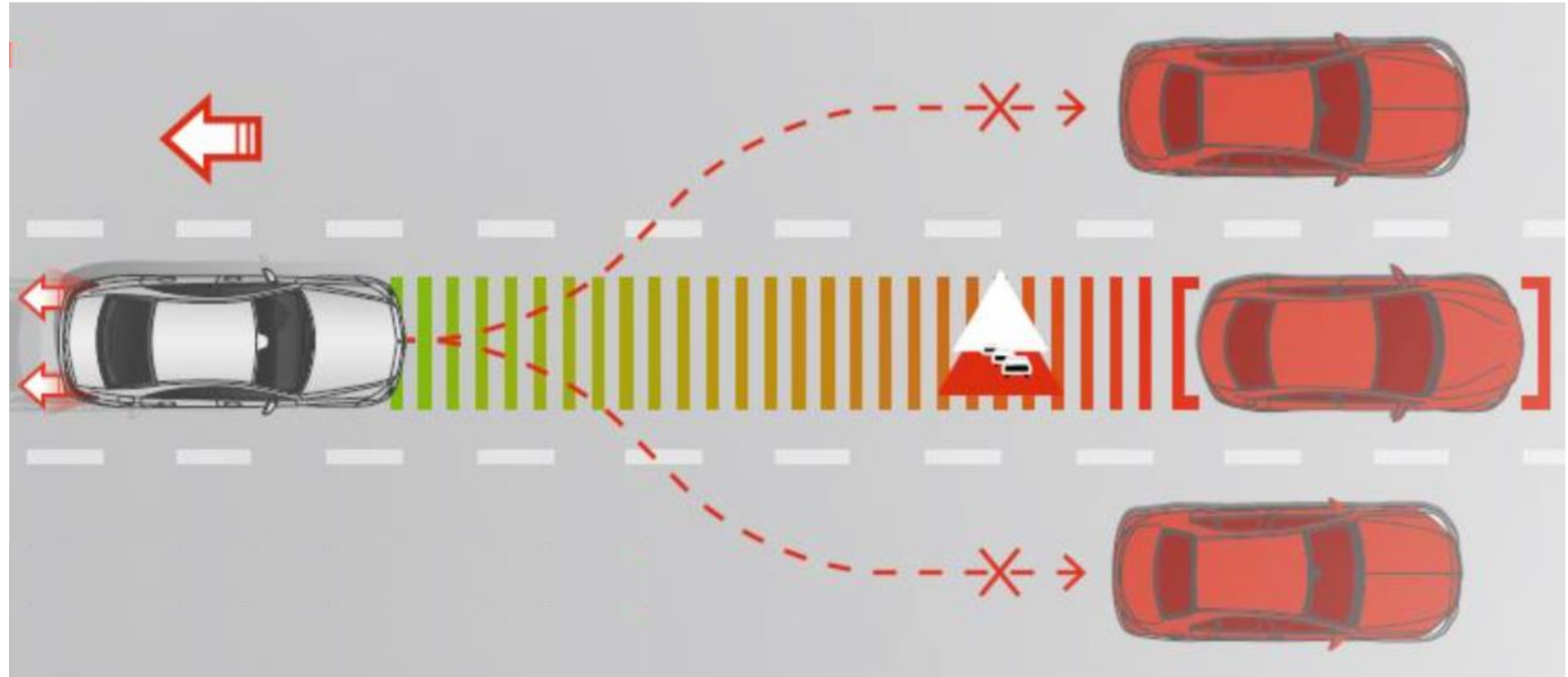
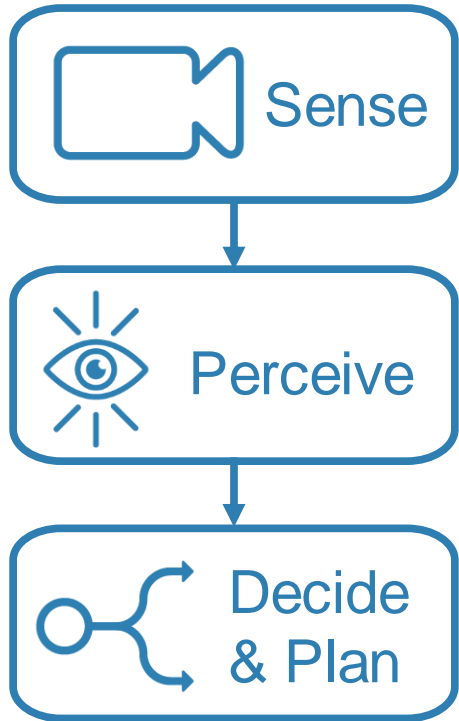

Capabilities of an Autonomous System

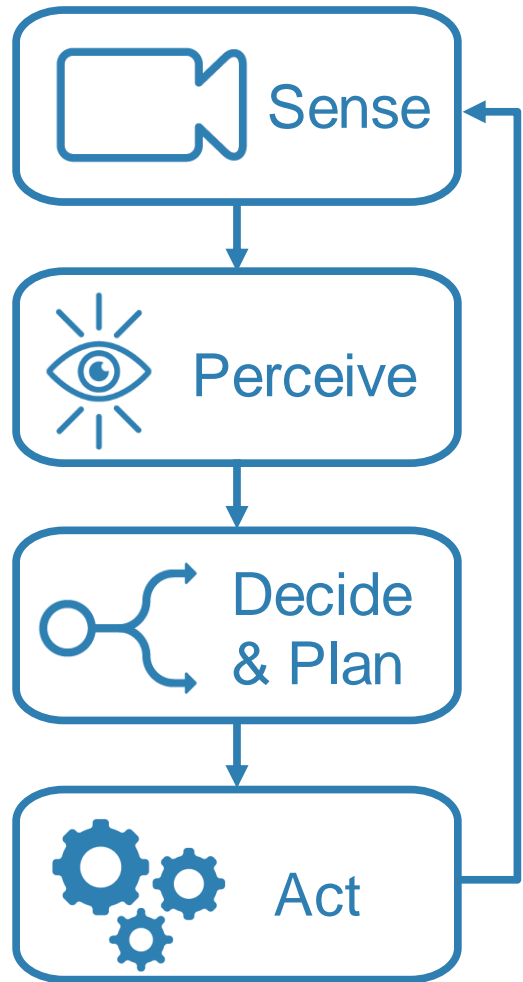

Autonomous Technology – Balancing Responsibility

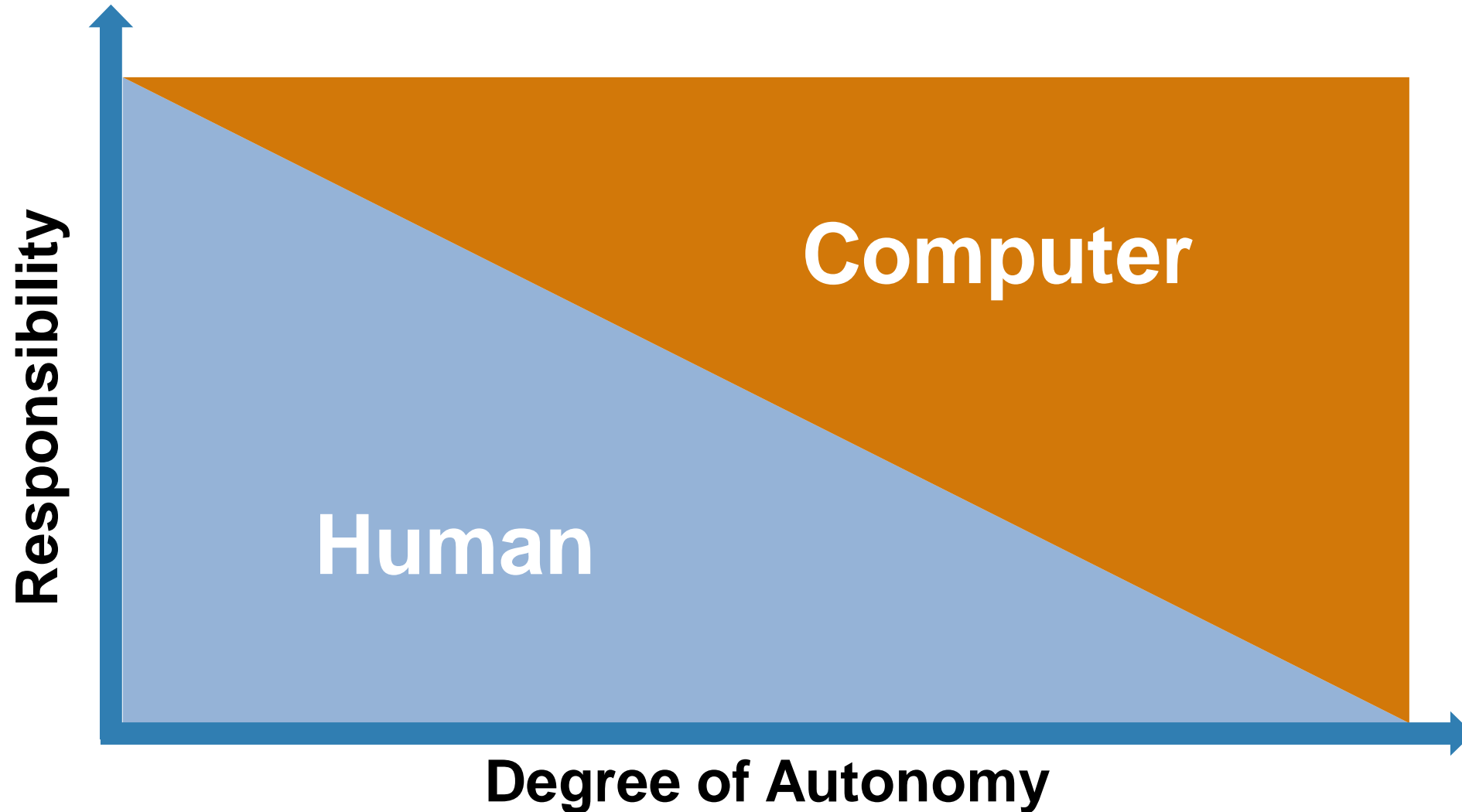

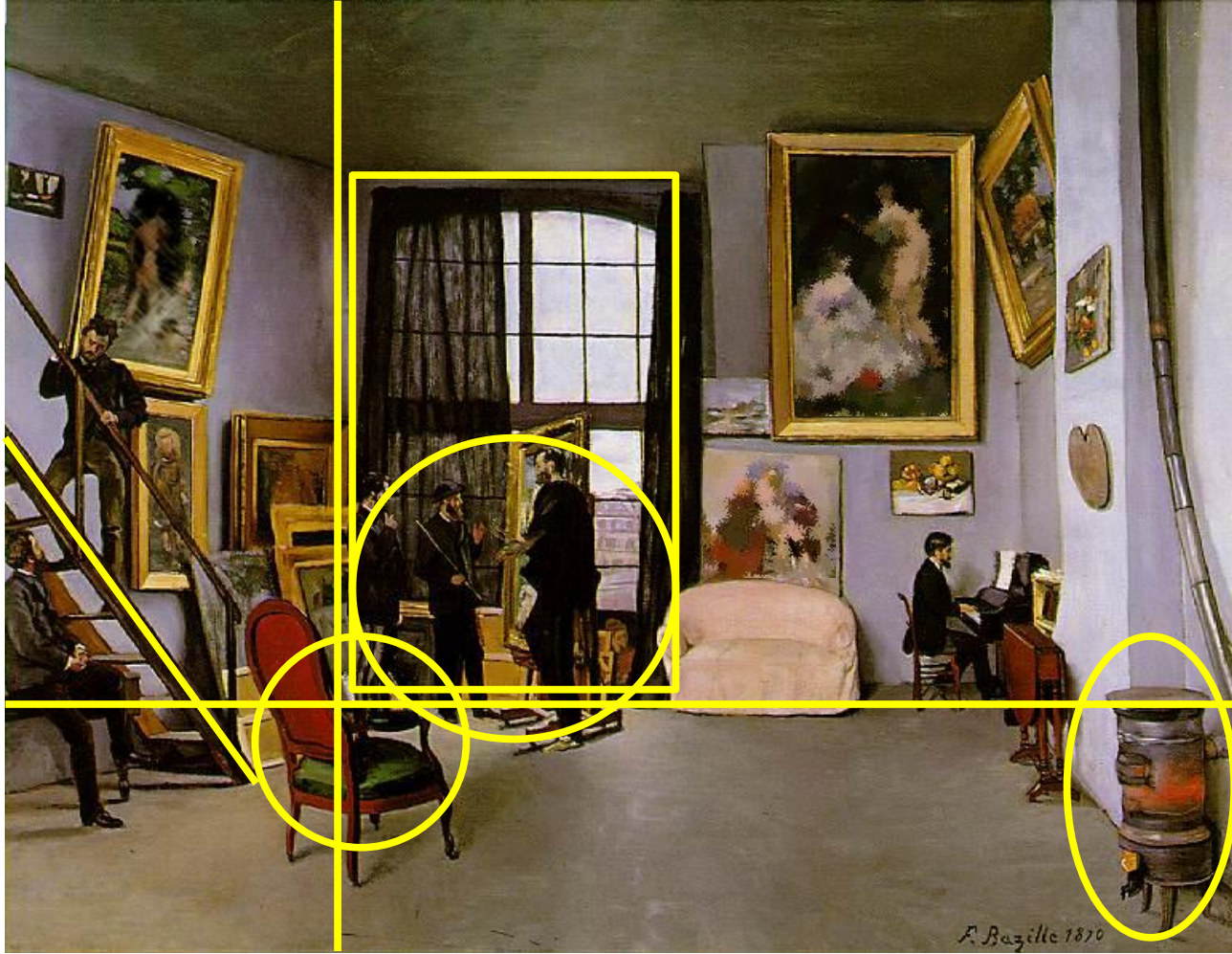

Bazille's Studio
Bazille 1870



Shuffleton's Barbershop
Rockwell 1950

Autonomous Artistic Style Classification

Rutgers University

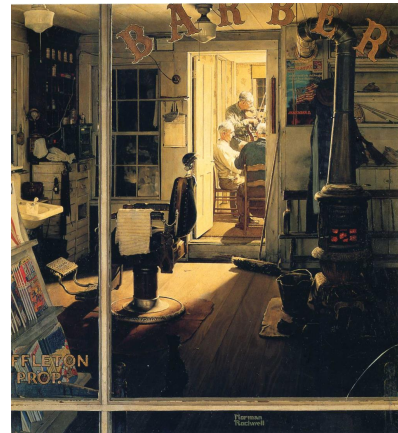
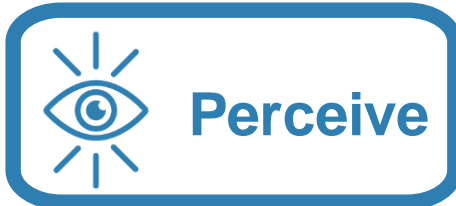
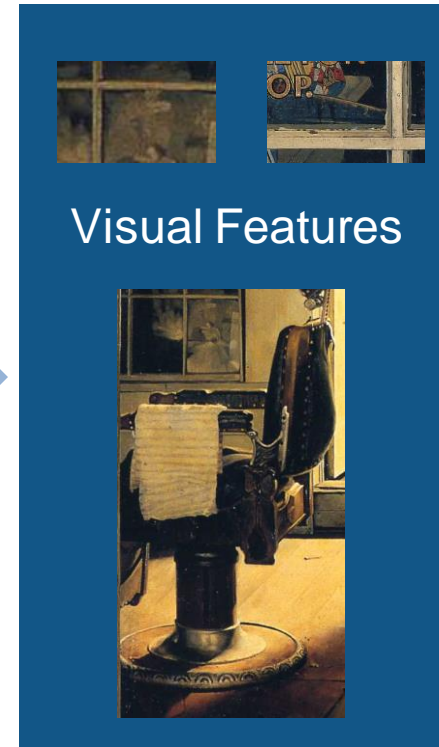

Image
Feature
Extraction



Machine
Learning
Classification



Style:
Regionalism



Genre:
Interior



Artist:
Rockwell

Where to add autonomy with perception?

- Analyze more data
- Reduce bias
- Improve measurement quality
- Save time
- Improve performance

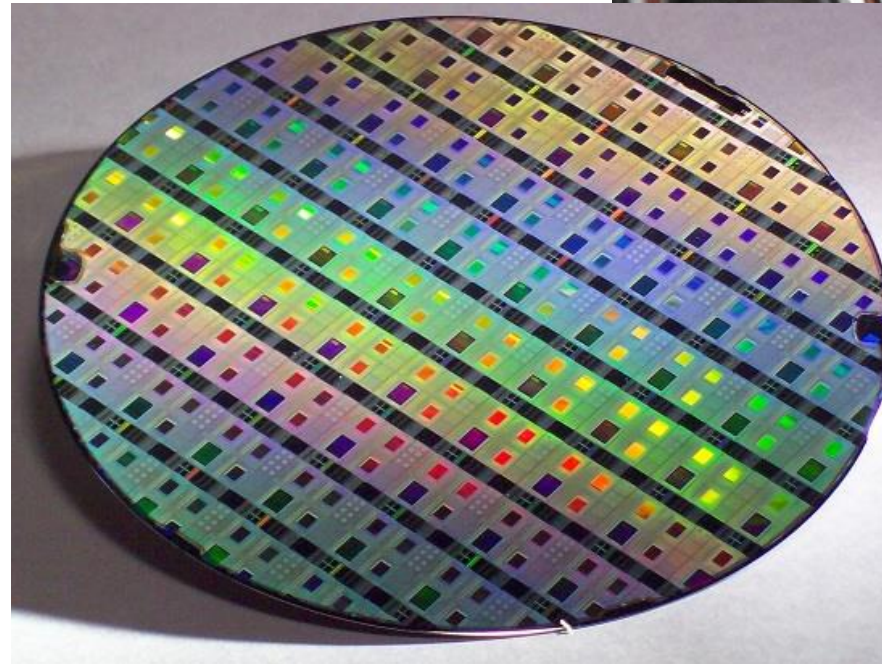

Virtual Semiconductor
Manufacturing Calibration

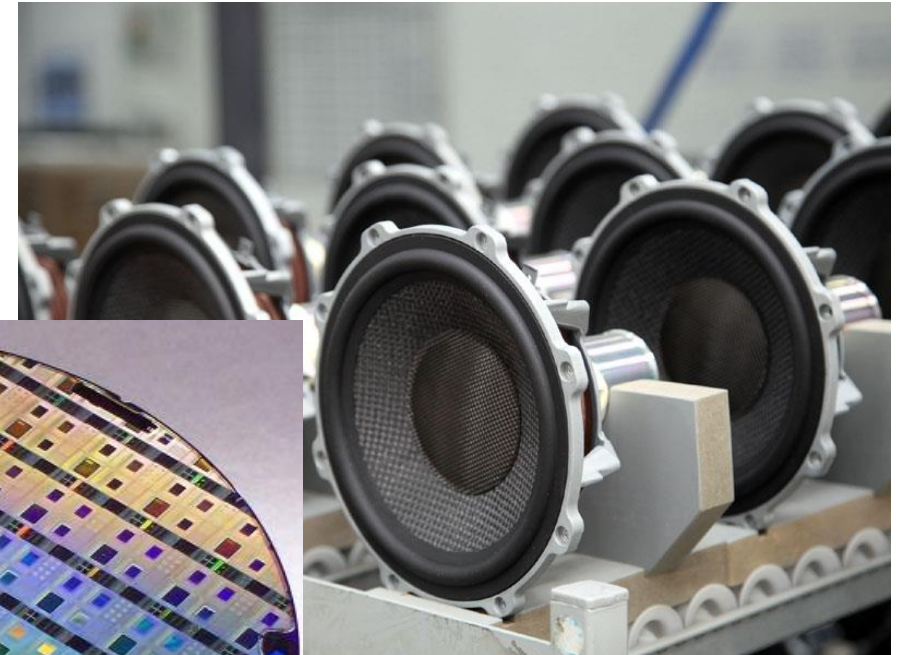

Determine
Loudspeaker
Quality

Cost of rig: \$1,000,000+

Repair cost: \$100,000

Cost of valve: \$200









Autonomous Service for Predictive Maintenance

Which sensor values should they use?

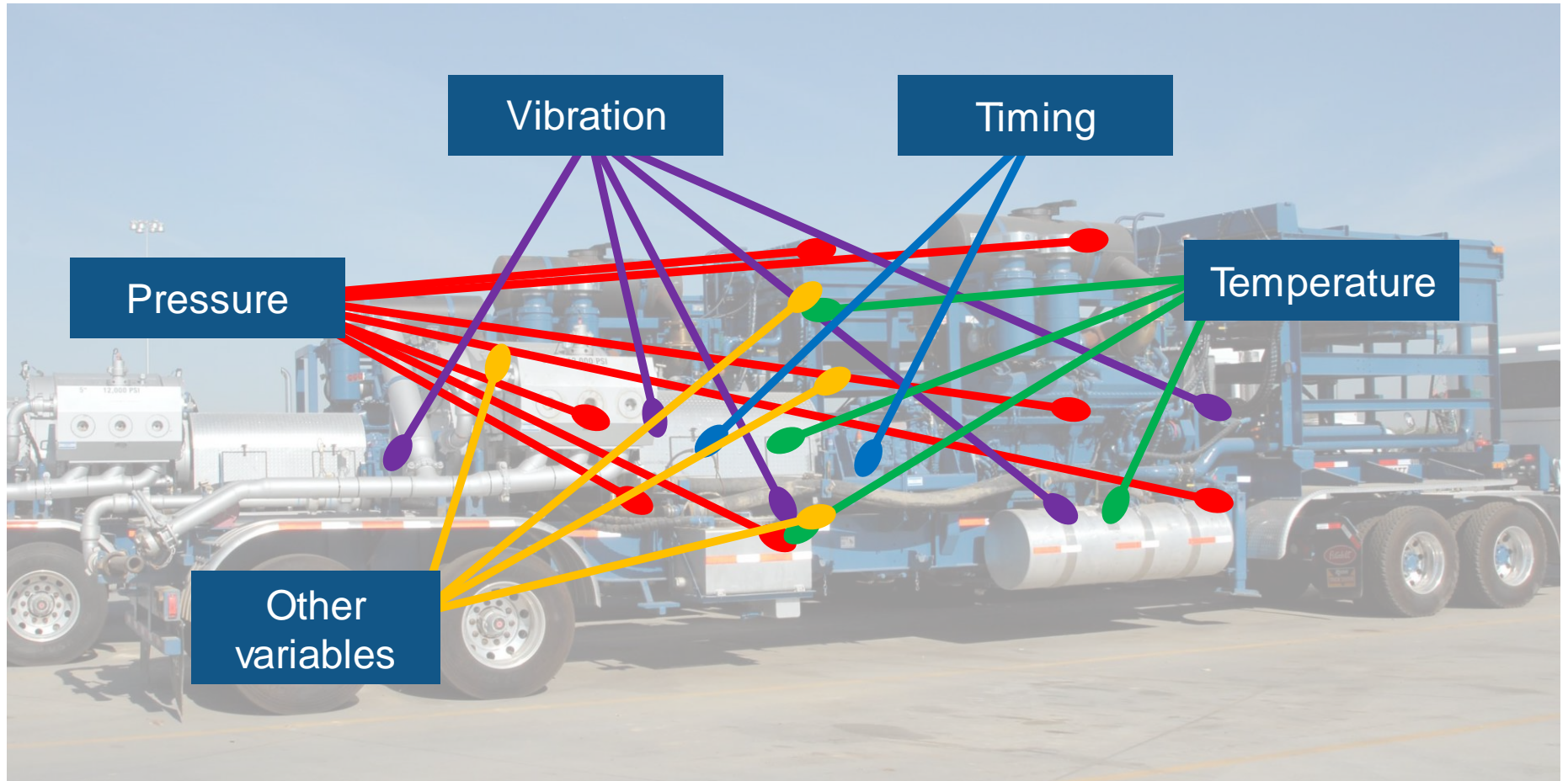

Autonomous Service for Predictive Maintenance

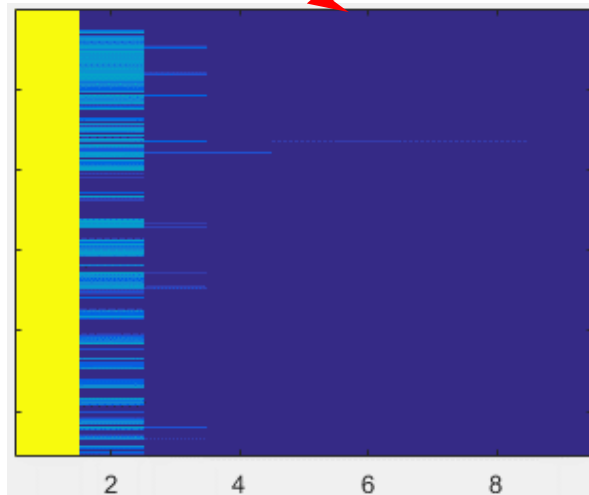
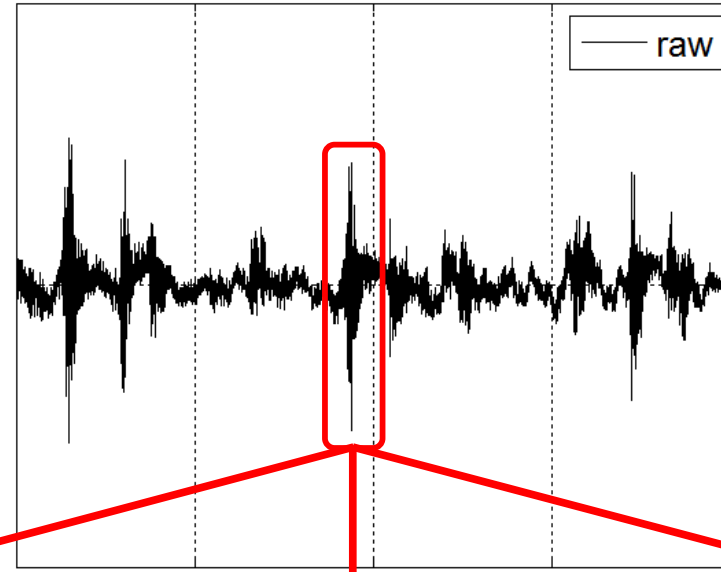
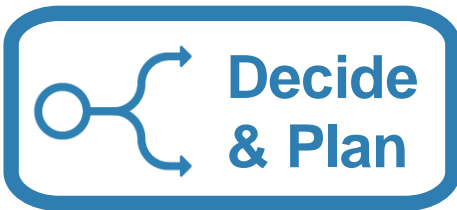
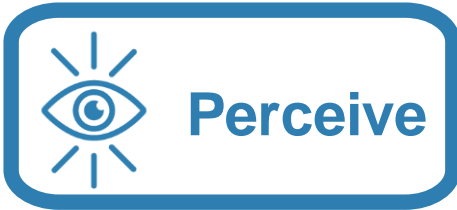

Normal Operation

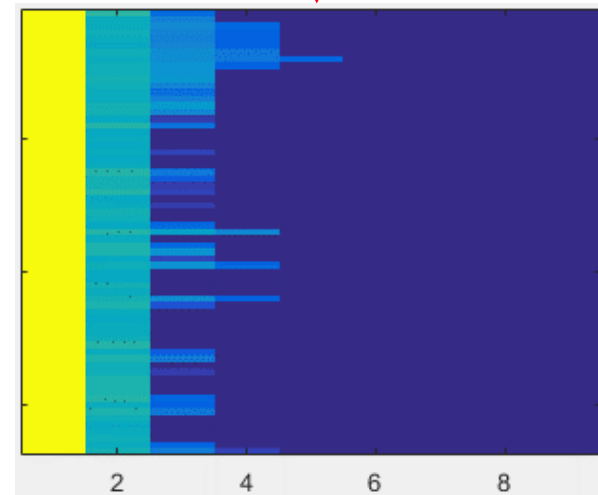

Monitor Closely

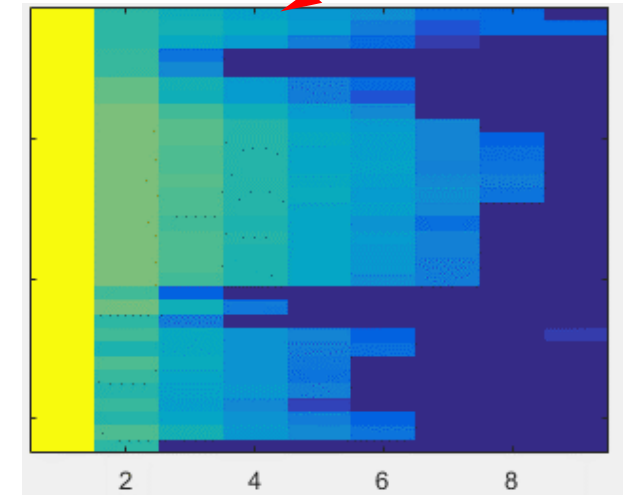

Maintenance Needed

Autonomous Service for Predictive Maintenance



Find out more:
Predictive Maintenance with
MATLAB and Simulink

Mehernaz Savai, MathWorks

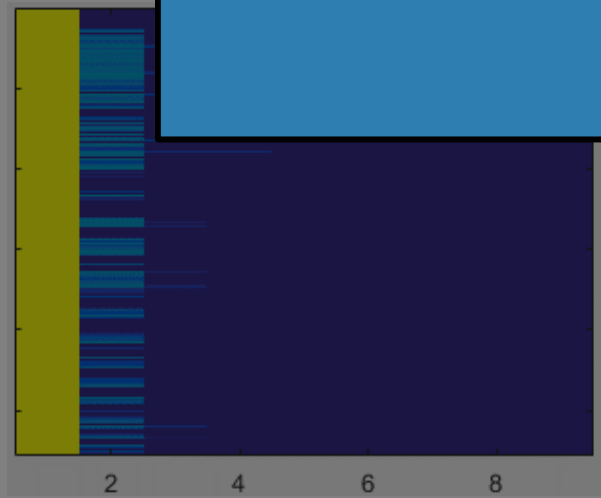
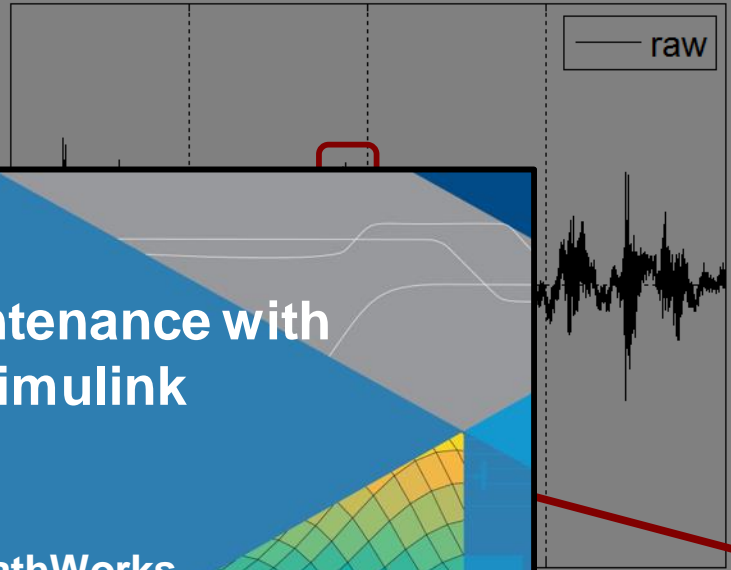

Normal Operation

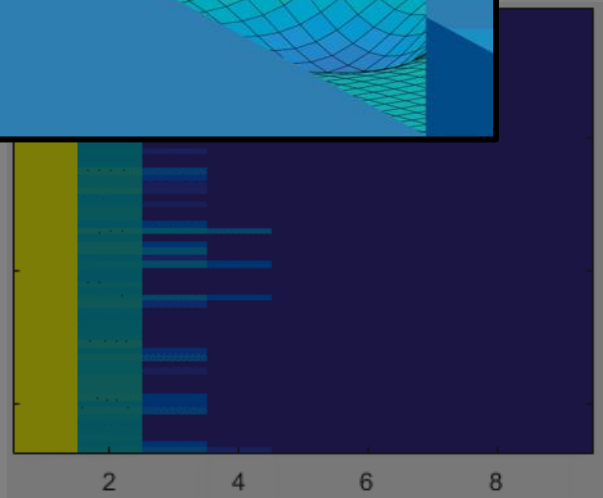

Monitor Closely

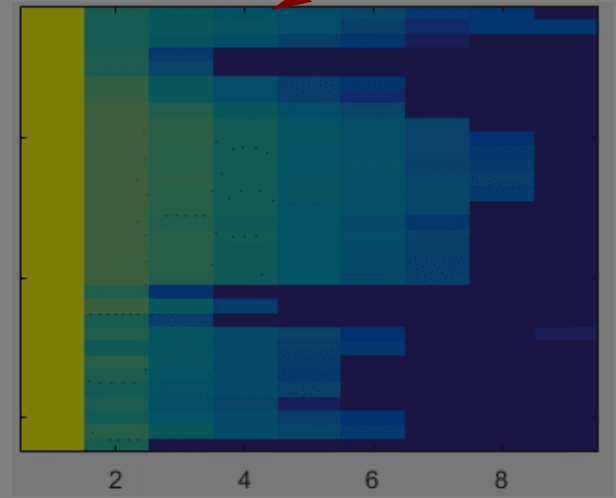

Maintenance Needed

Machine Learning or Deep Learning?

Machine Learning Approach

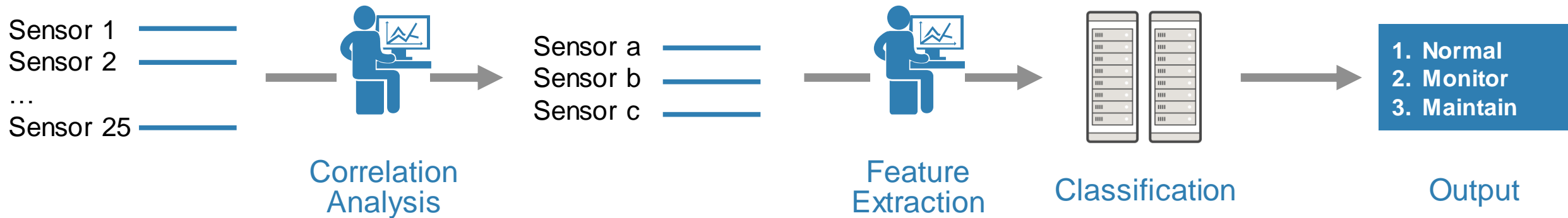

Deep Learning Approach



Machine Learning and Deep Learning

- Configure and train models using object detection algorithms (*R-CNN, Fast R-CNN, Faster R-CNN*)
- Leverage pretrained models for transfer learning (*AlexNet, VGG-16, VGG-19*)
- Import models from Caffe
- Train networks using multiple GPUs

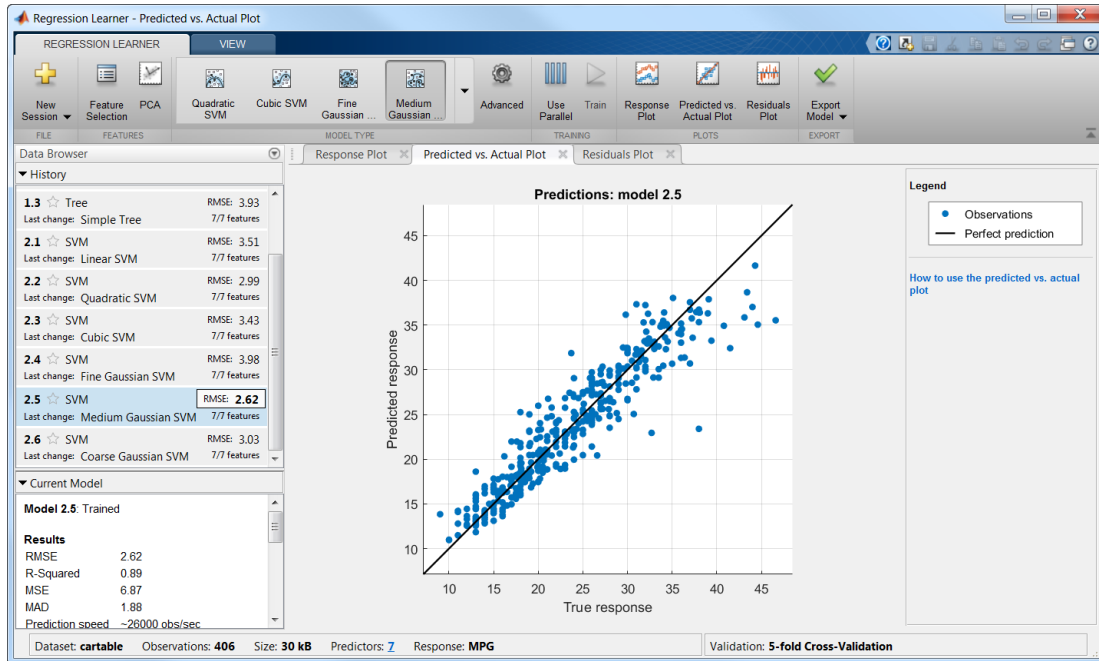

Regression Learner app

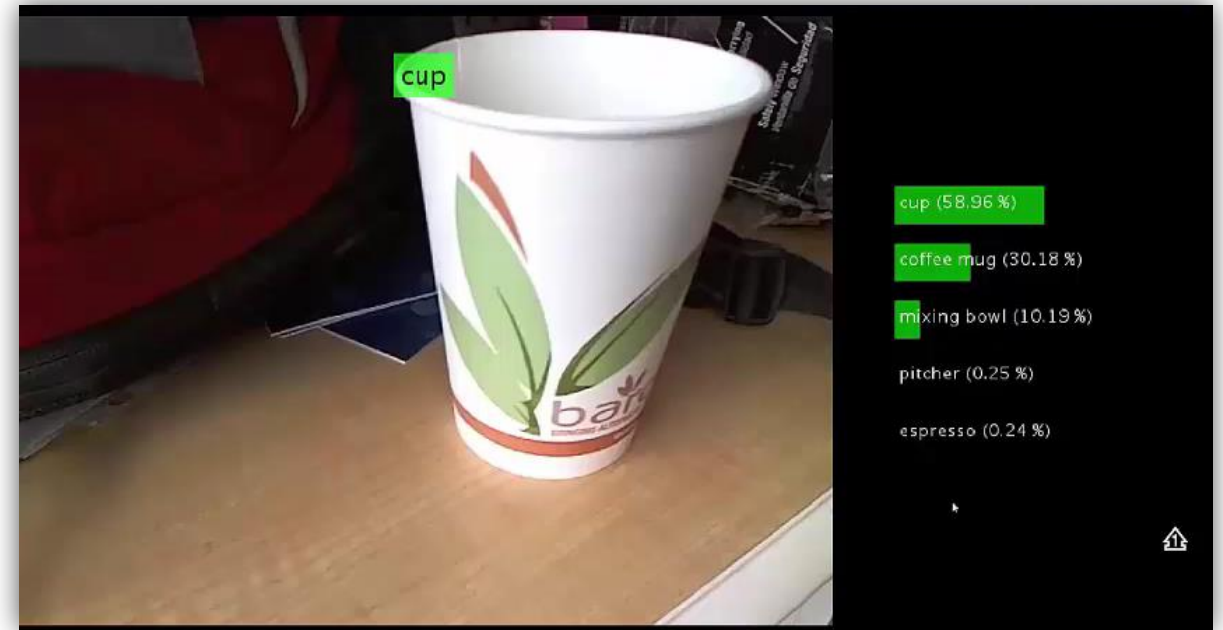

R2017b Mega Release of Deep Learning Capabilities

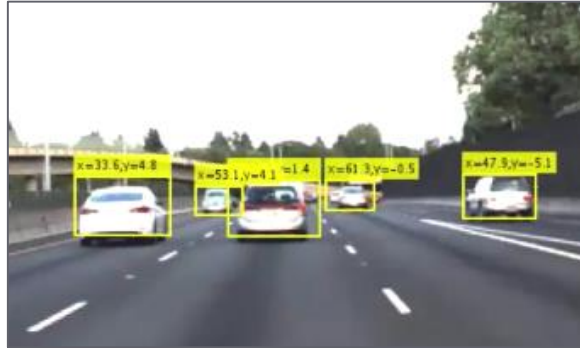

Design Deep Learning
& Vision Algorithm

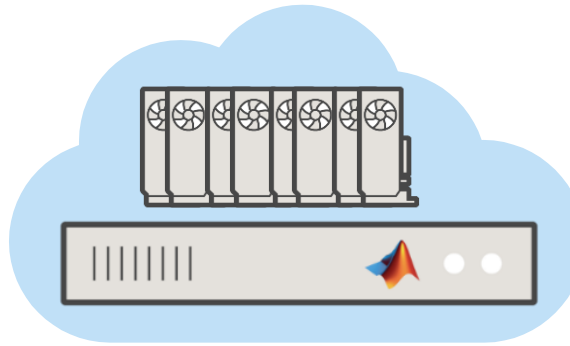

Accelerate and Scale
Training



High Performance
Embedded Implementation

Deep learning design is **easy**
in MATLAB

Apps for Ground Truth Labeling,
Pixel Labeling
Pre-trained **model importer**
Training Visualization

Parallel Computing Toolbox

Train
4x faster than TensorFlow
(on TitanXP)

GPU Coder

7x faster than TensorFlow
5x faster than pyCaffe
(on TitanXP)
2x faster than C++ Caffe
(on Jetson)

R2017b Mega Release of Deep Learning Capabilities

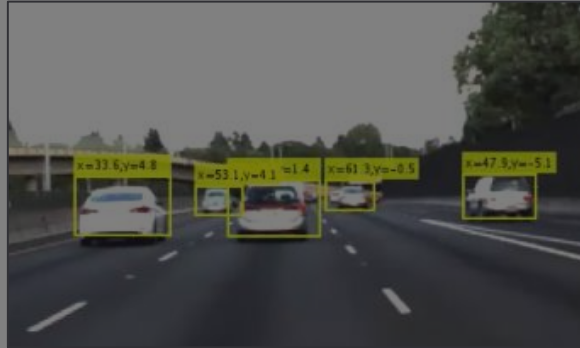

Design Deep Learning
& Vision Algorithm

Find out more:
Deep Learning: Transforming
Engineering and Science

Avinash Nehemiah, MathWorks
Amit Goel, NVIDIA

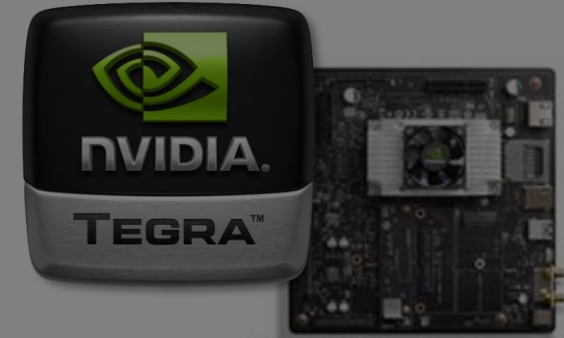

High Performance
Embedded Implementation

Deep learning design is **easy**
in MATLAB

Apps for Ground Truth Labeling,
Pixel Labeling
Pre-trained **model importer**
Training Visualization

Parallel Computing Toolbox

Train
4x faster than TensorFlow
(on TitanXP)

GPU Coder

7x faster than TensorFlow
5x faster than pyCaffe
(on TitanXP)
2x faster than C++ Caffe
(on Jetson)

What are the best predictors?

- Data-driven
- Model-driven

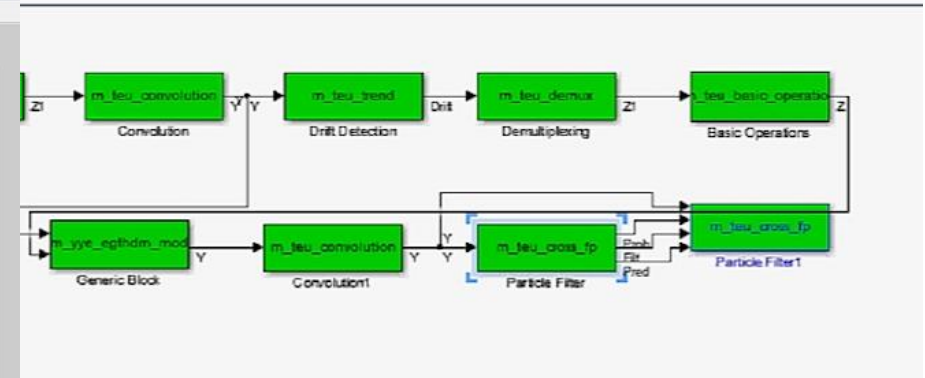
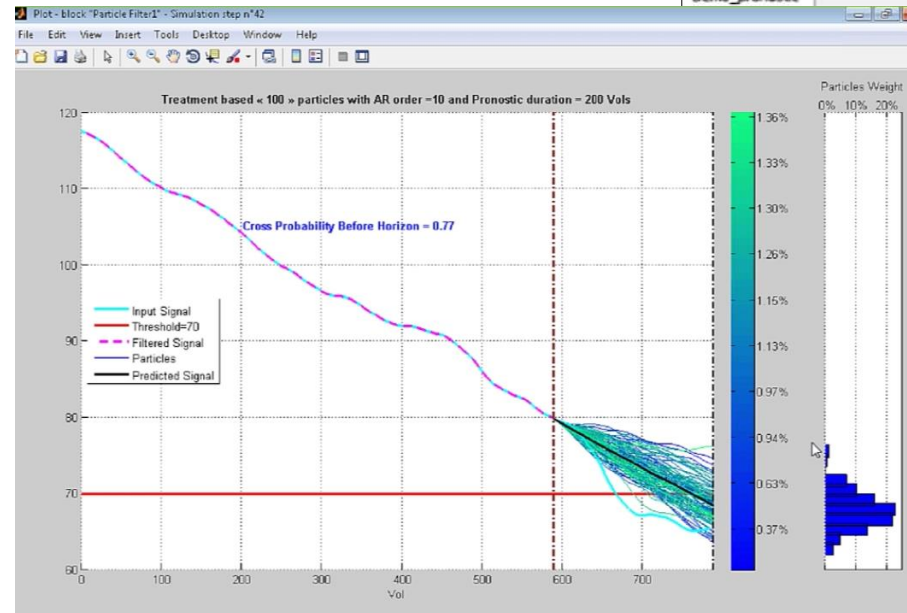
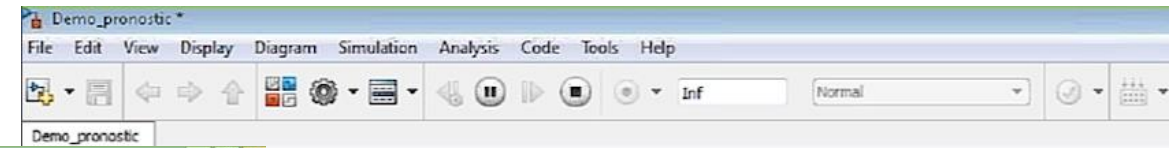

Jet Engine Monitoring

Autonomous Glucose Level Management



Autonomous Glucose Level Management

Bigfoot Biomedical

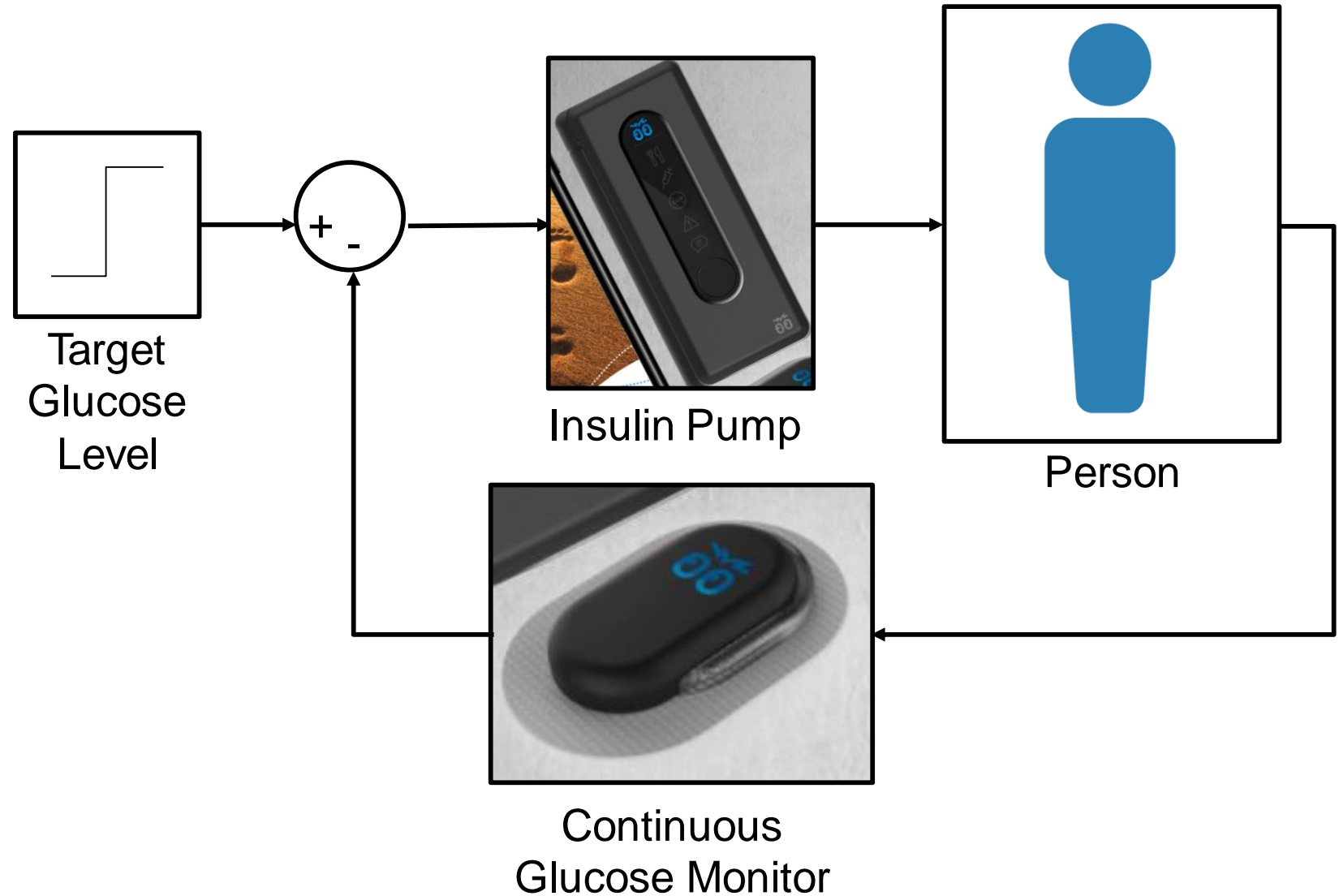
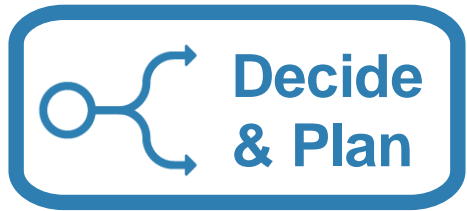
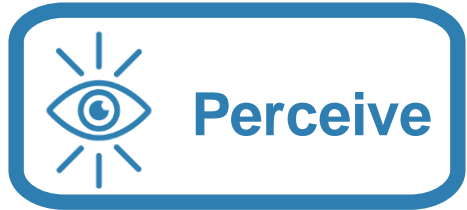

Autonomous Glucose Level Management

Bigfoot Biomedical

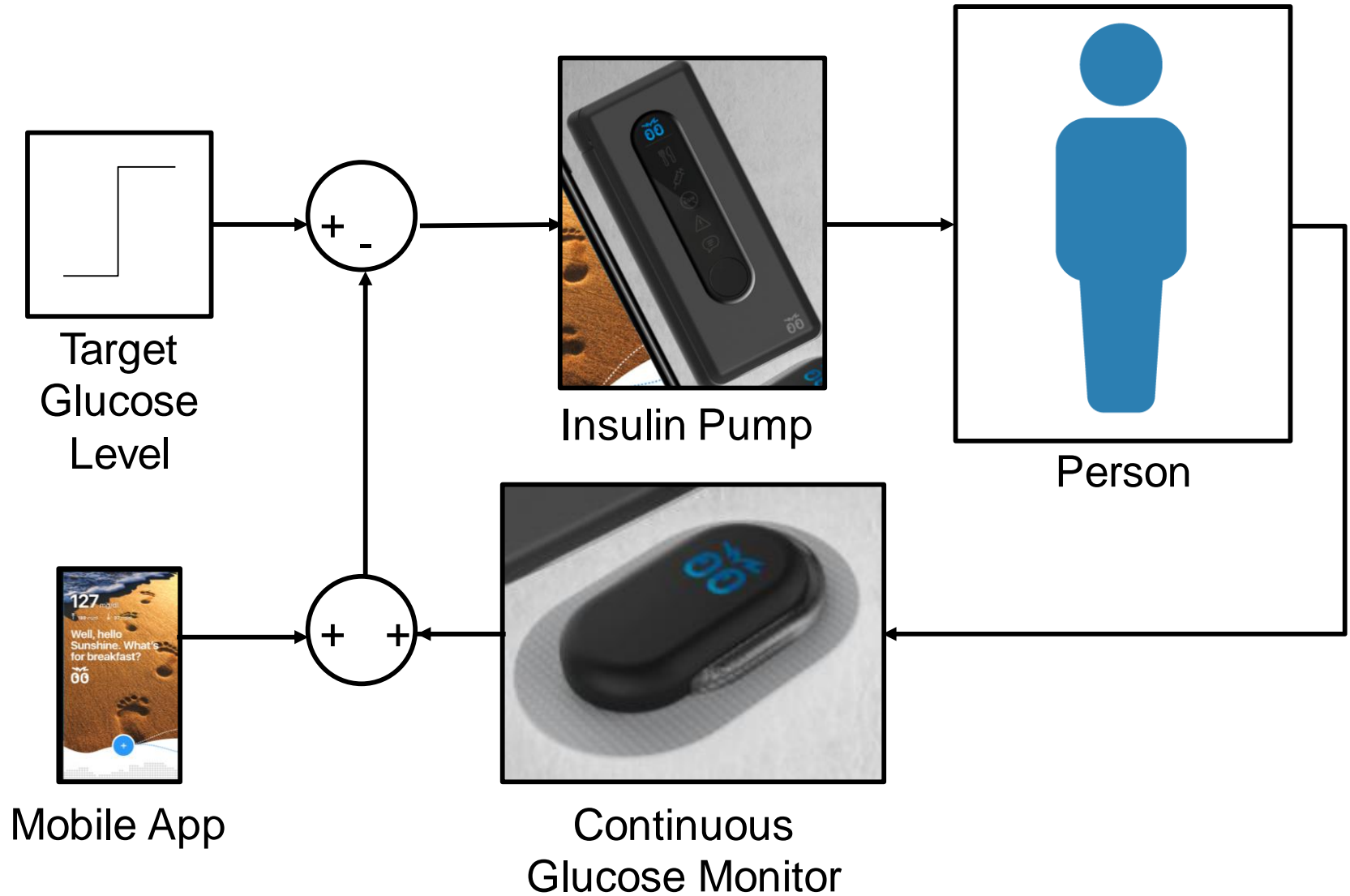
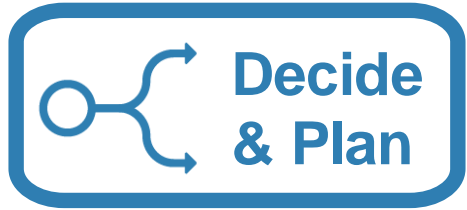
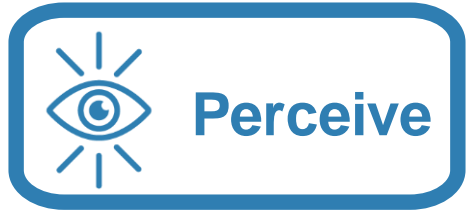

Autonomous Glucose Level Management

Bigfoot Biomedical

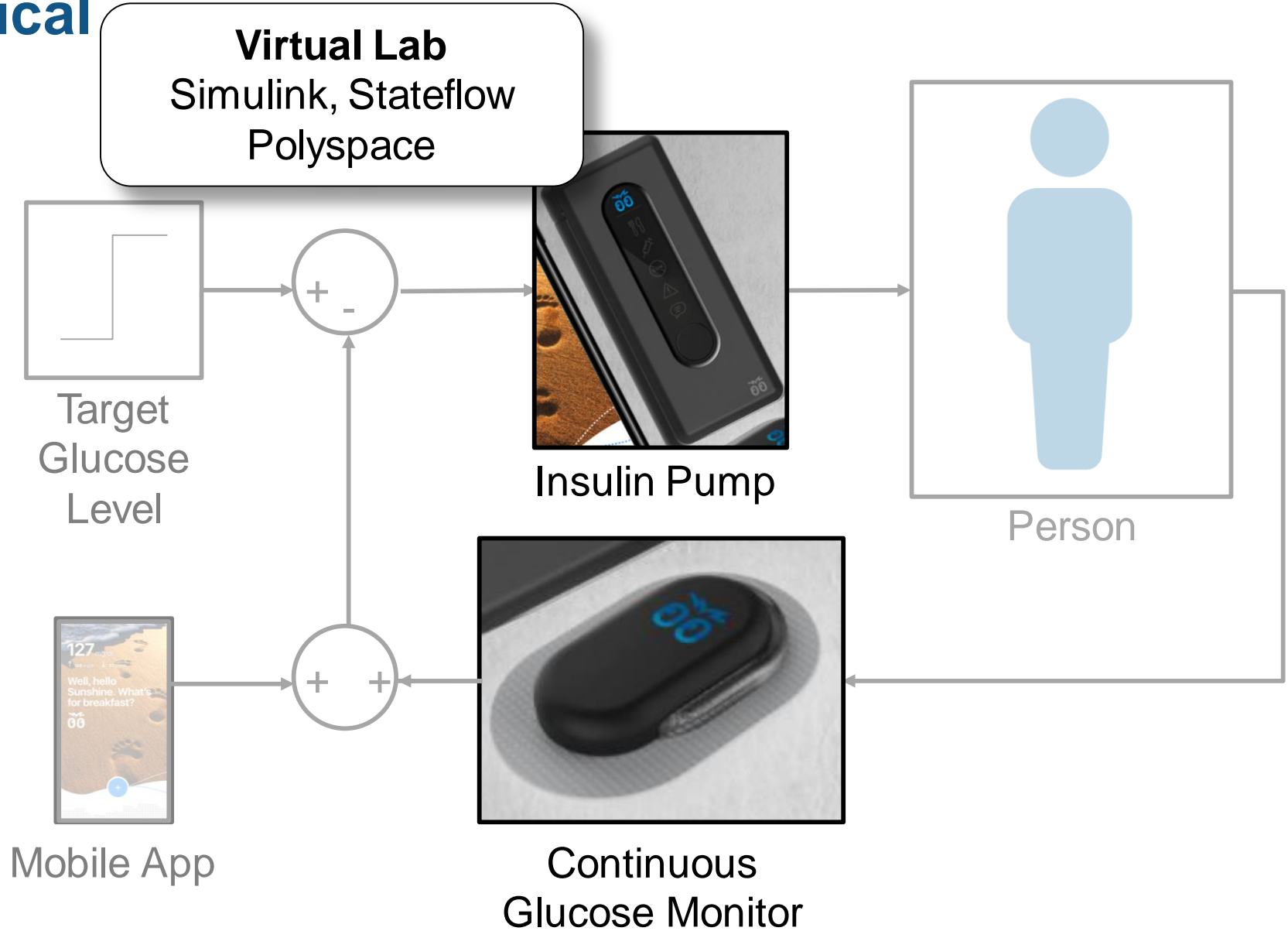

Autonomous Glucose Level Management

Bigfoot Biomedical

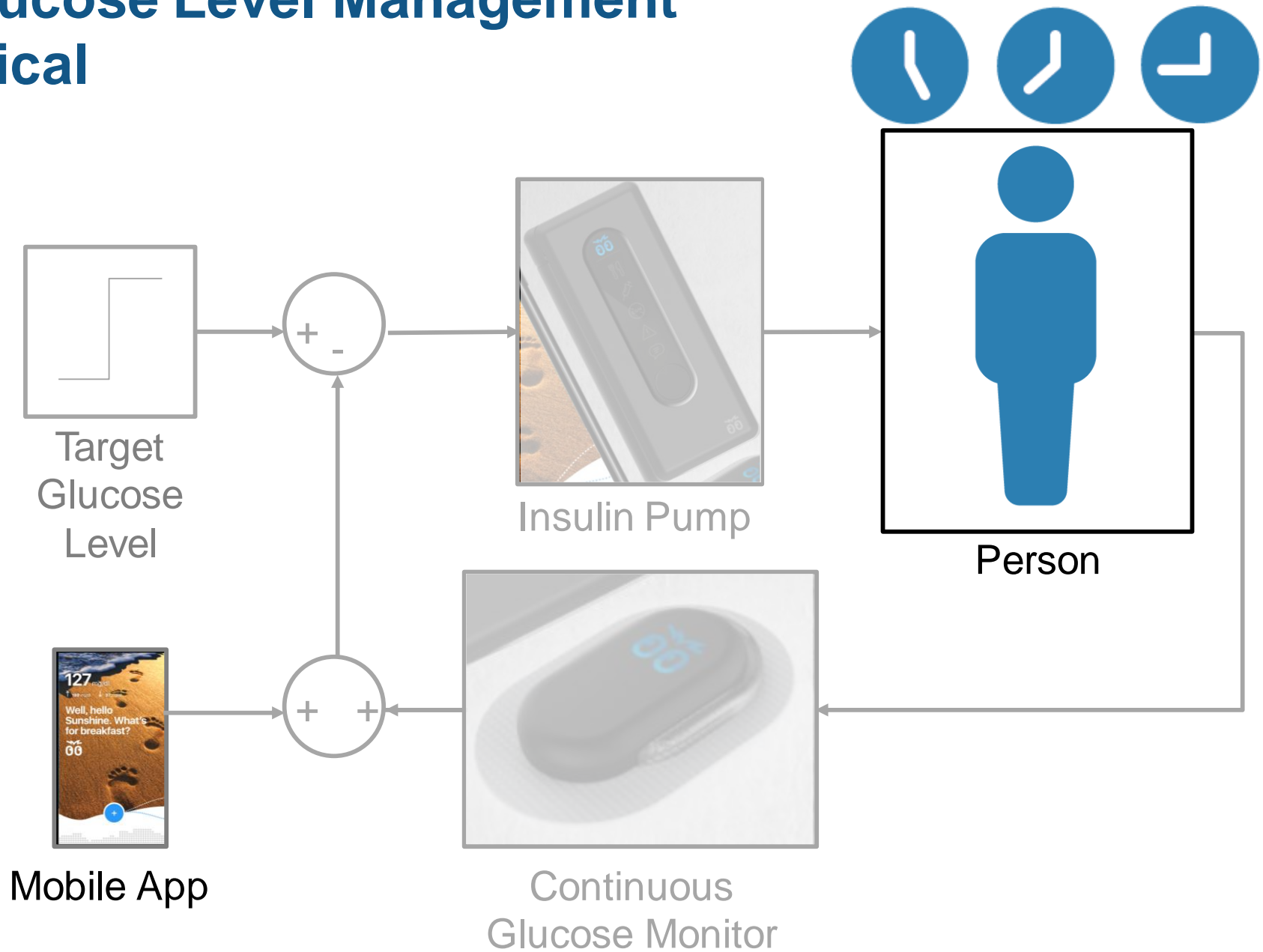
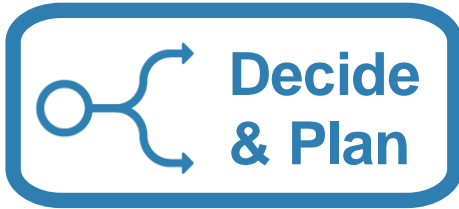

Autonomous Glucose Level Management

Bigfoot Biomedical

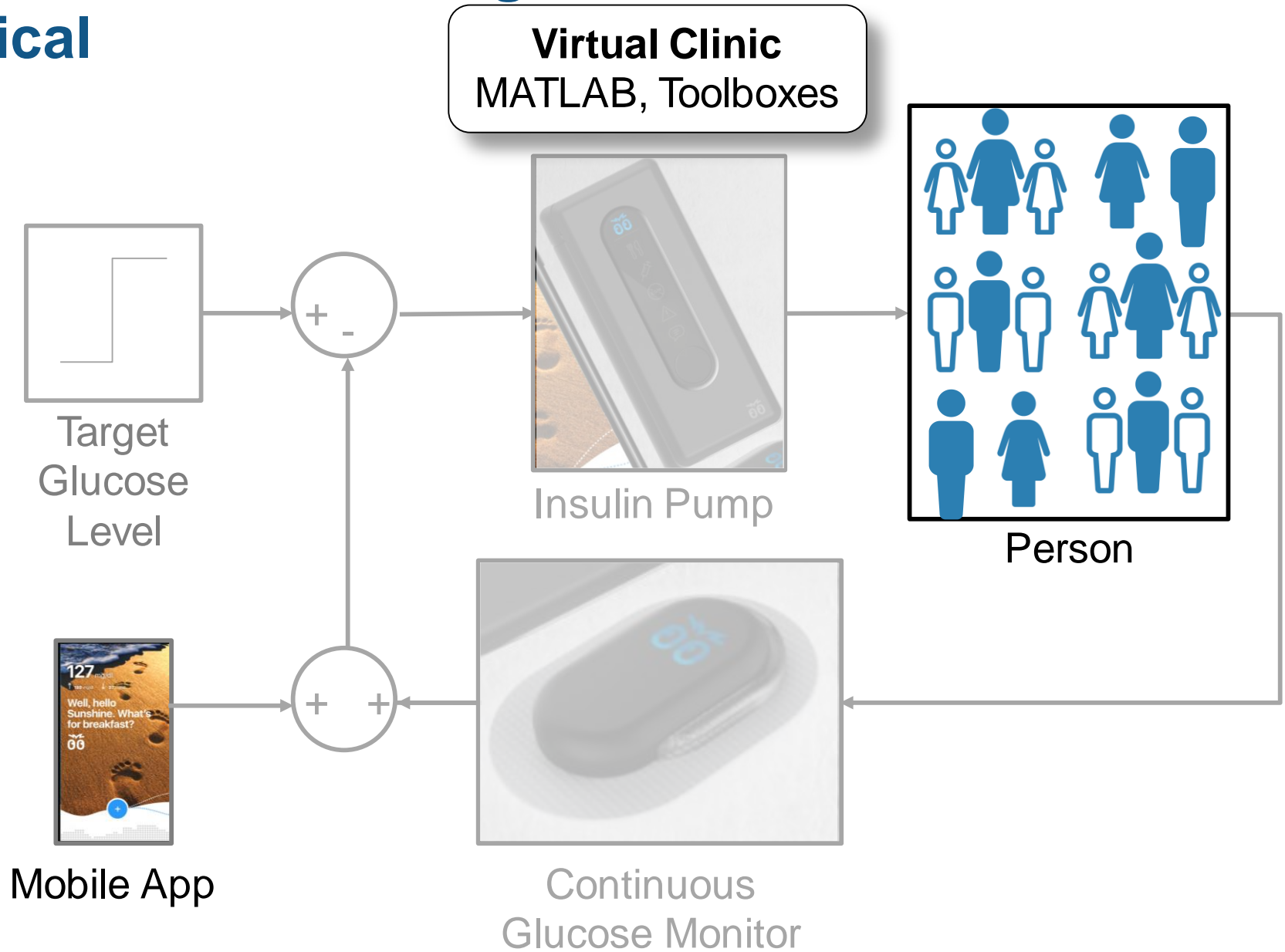
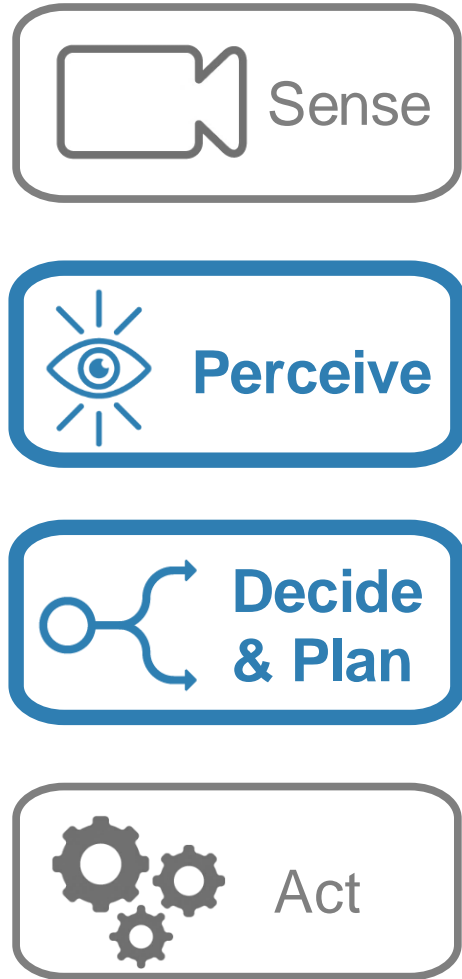

Virtual Clinic

Generating data through simulation

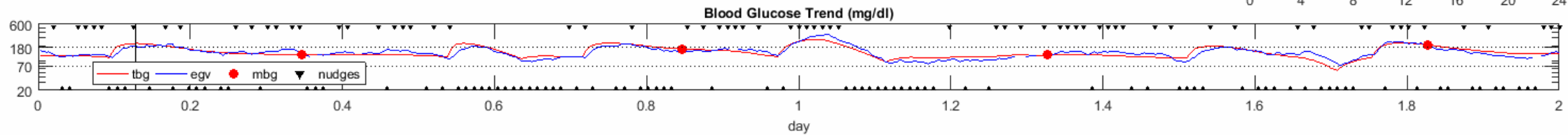
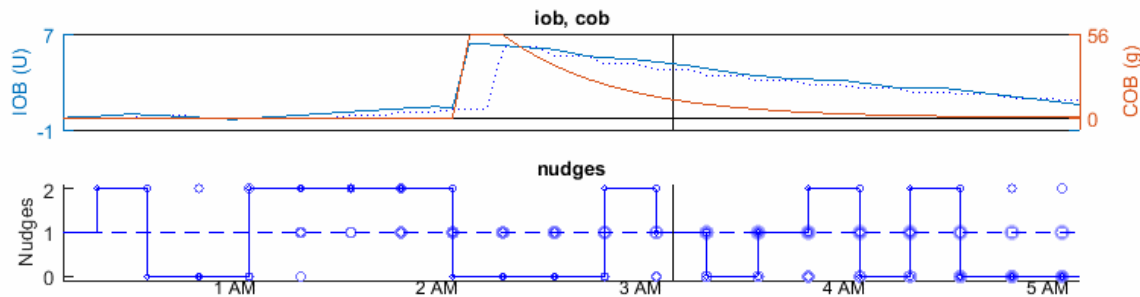
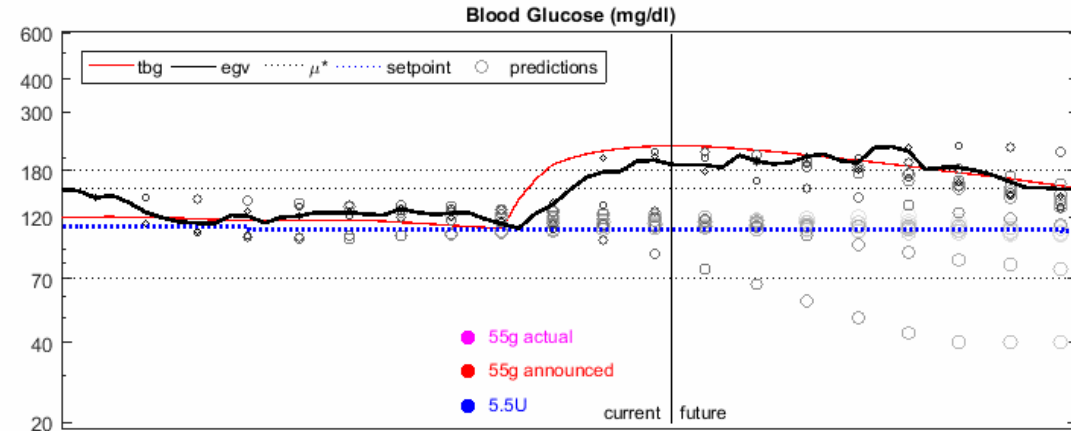
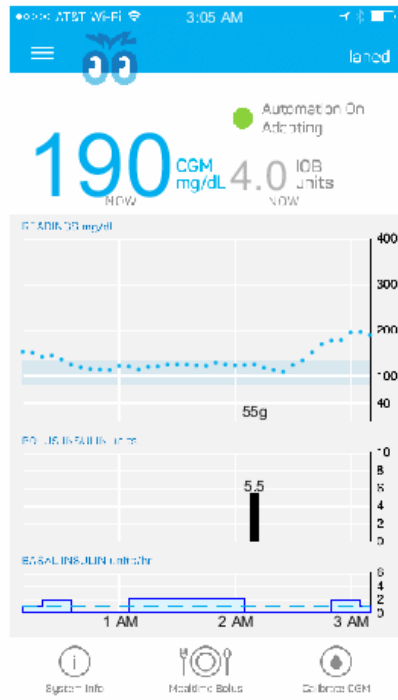

CRC Protocol, Nominal, No Mismatch

Purpose: Demonstrate expected behavior during CRC protocol. **Method:** Exercise, meal, bolus per CRC protocol. BR 24 U/day, CR 10 g/U, ISF 40 mg/dL/U. No settings mismatch. Unmeasured disturbances, diurnal setting variations. CGM drift, dropouts, calibration, and miscalibration. **Expected Result:** No adverse events.

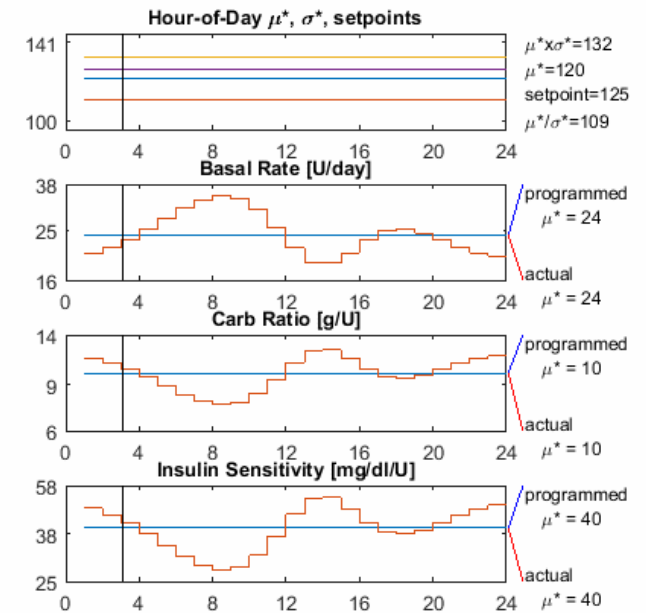

Virtual Clinic

Scaling computations to simulate 50 million patients a day

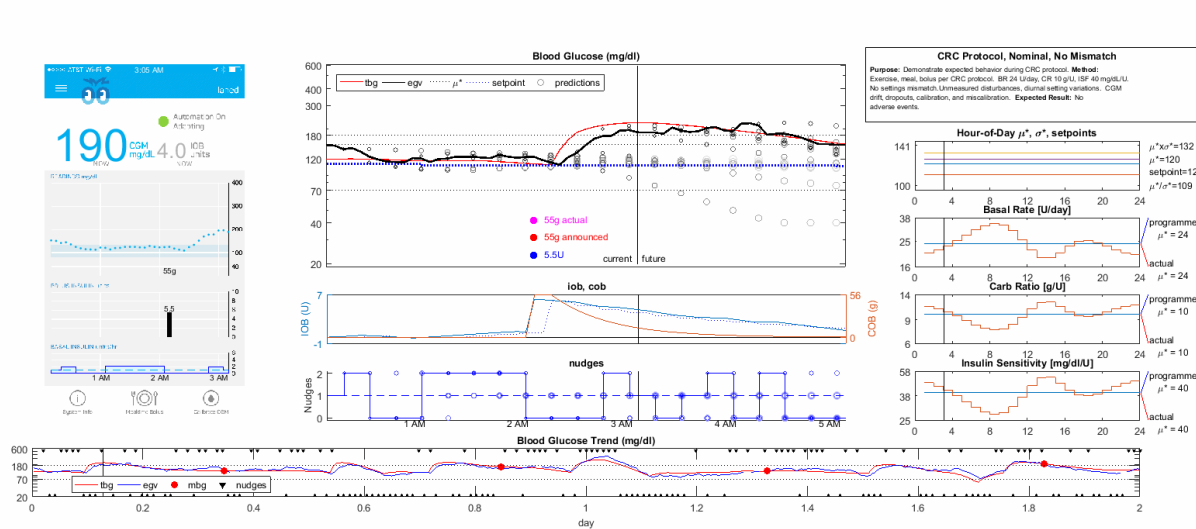

Where will you get your data?

- Simulation
- Public repositories
- In the field
- In the lab
- Internet of Things (IoT)

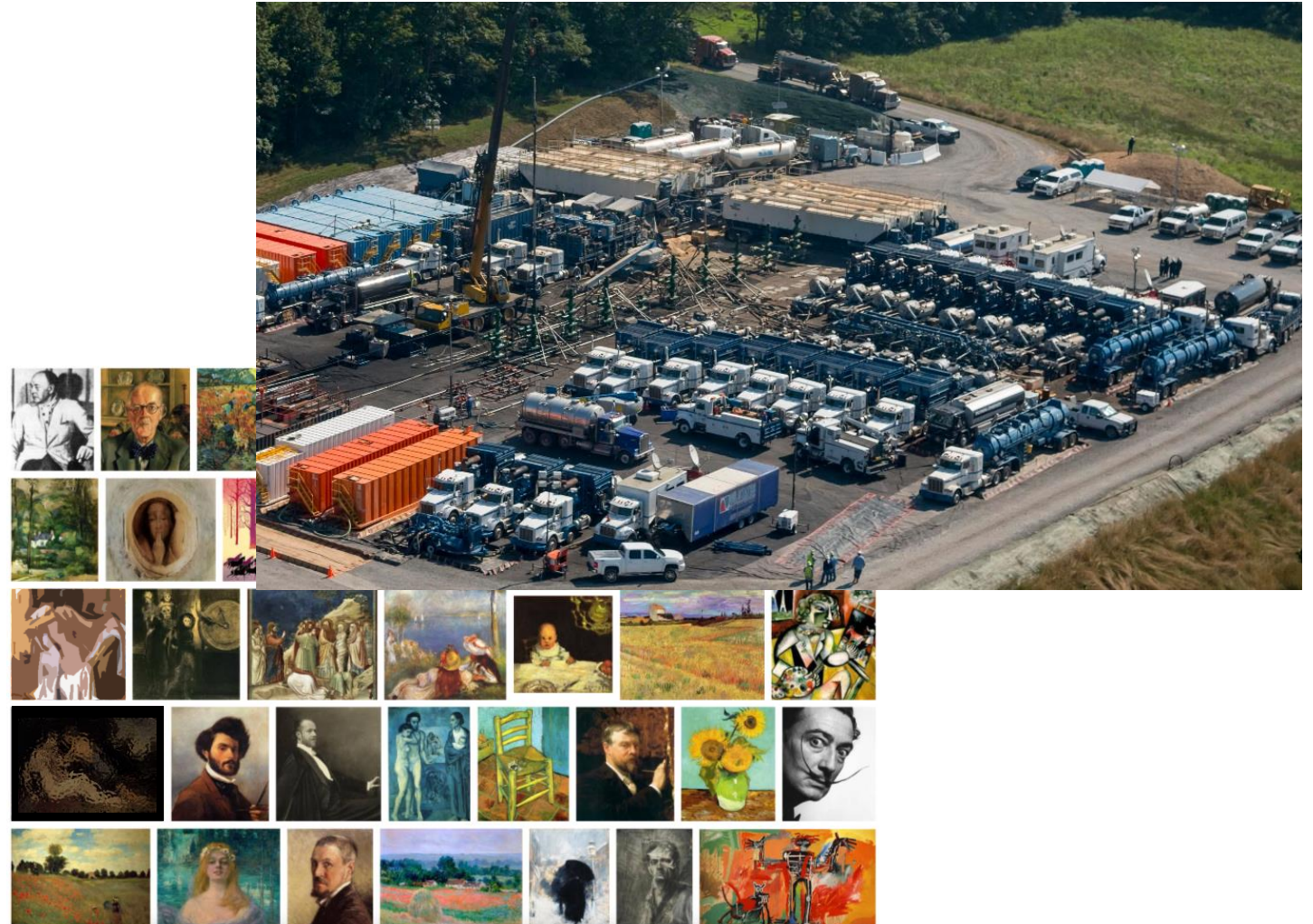

Working with Big Data Just Got Easier

Tall arrays in MATLAB

R2016b

R2017a

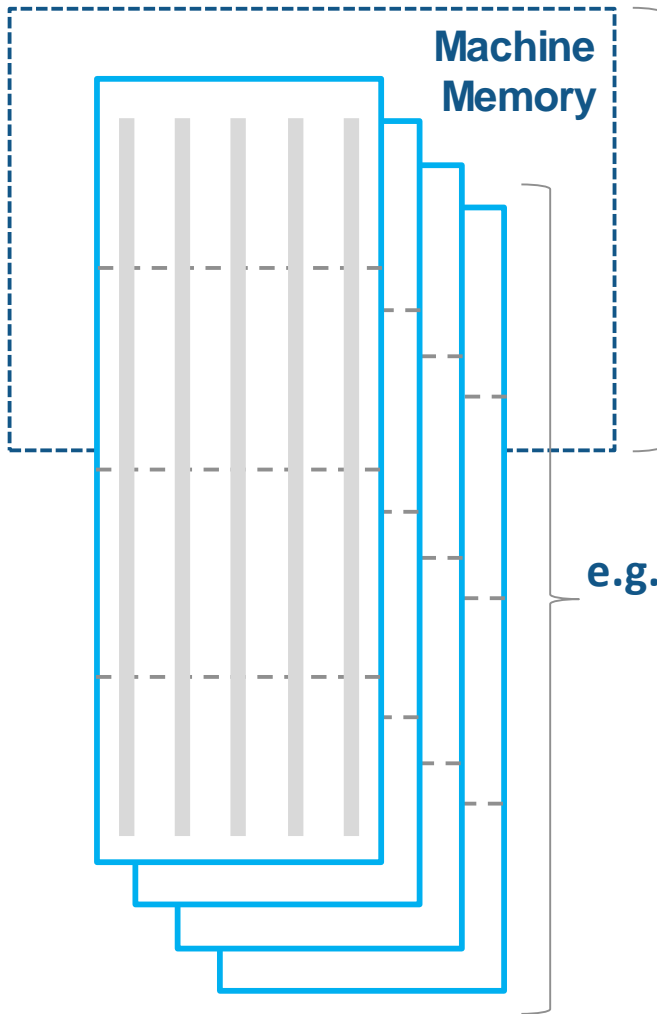

e.g. 100GB~
1TB

Tall Data

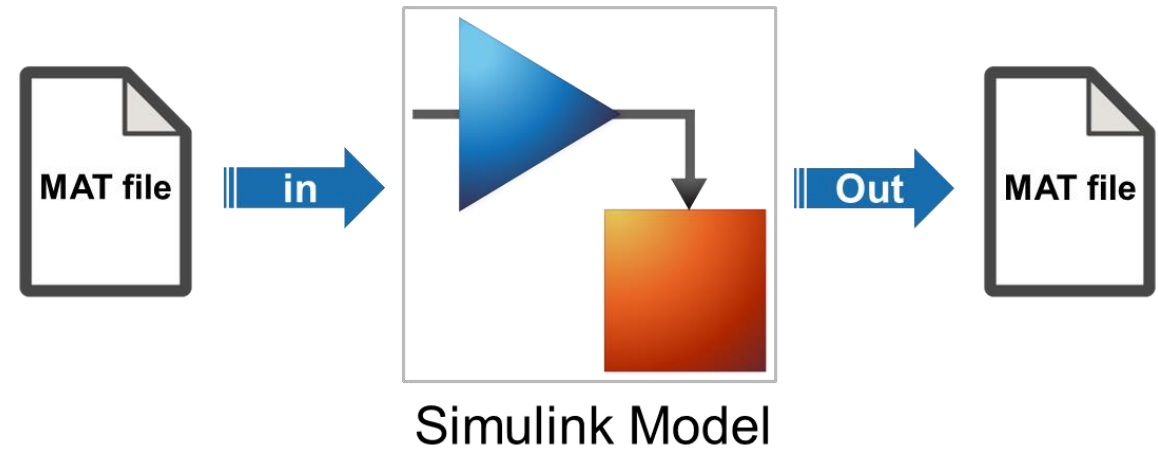

Stream large input signals from MAT-files

R2017a





Autonomous Trailer Filling

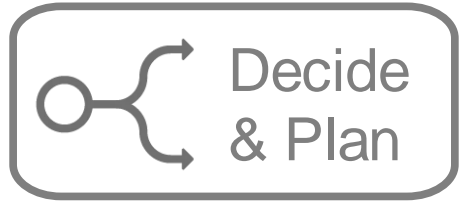
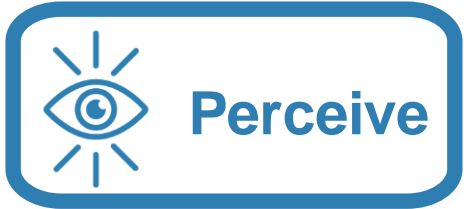

Autonomous Trailer Filling

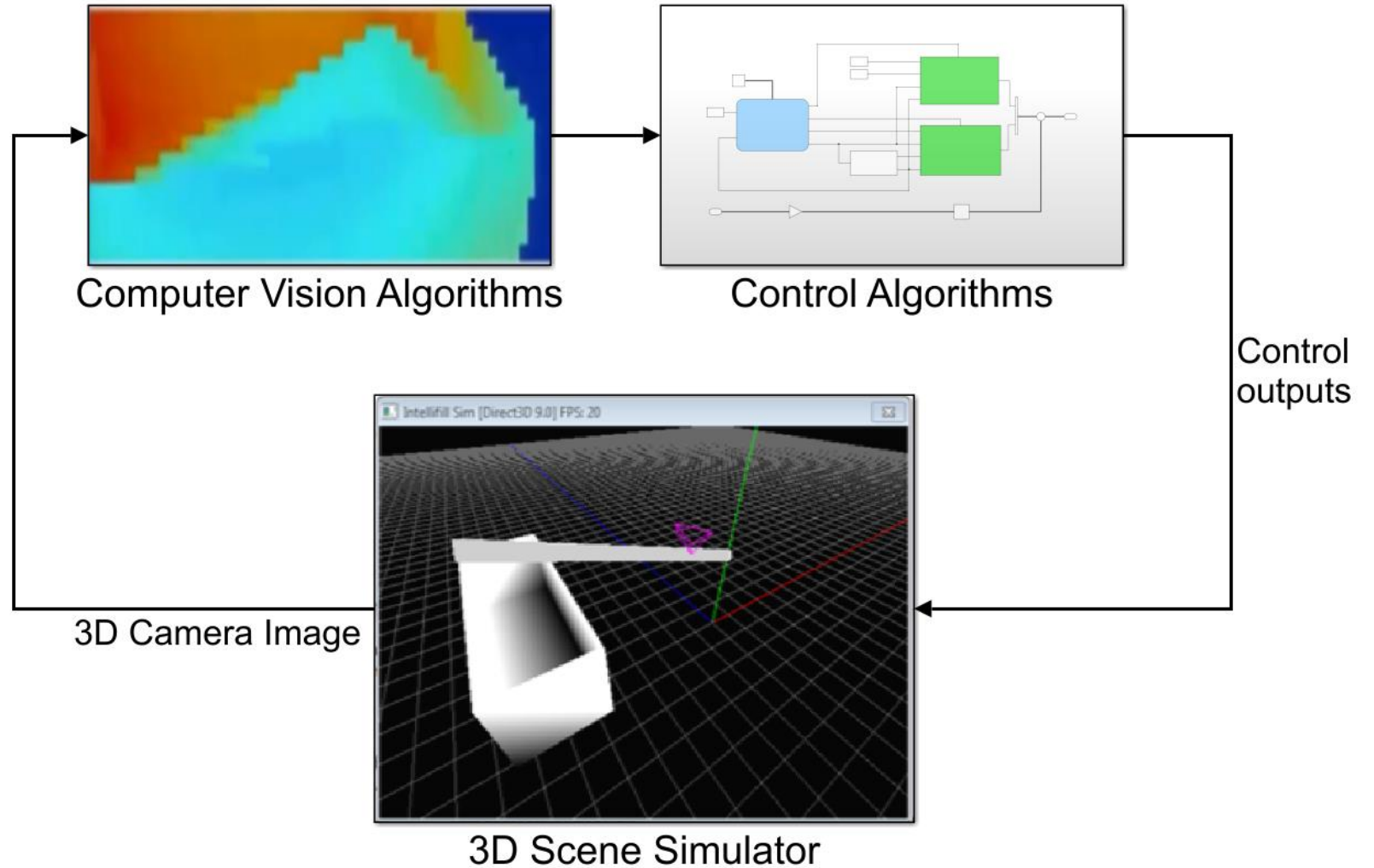

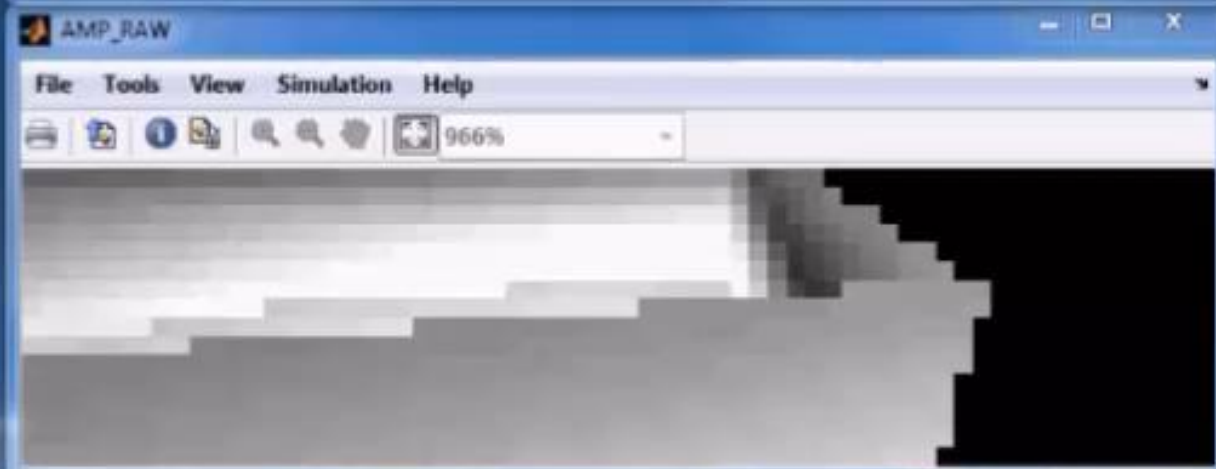
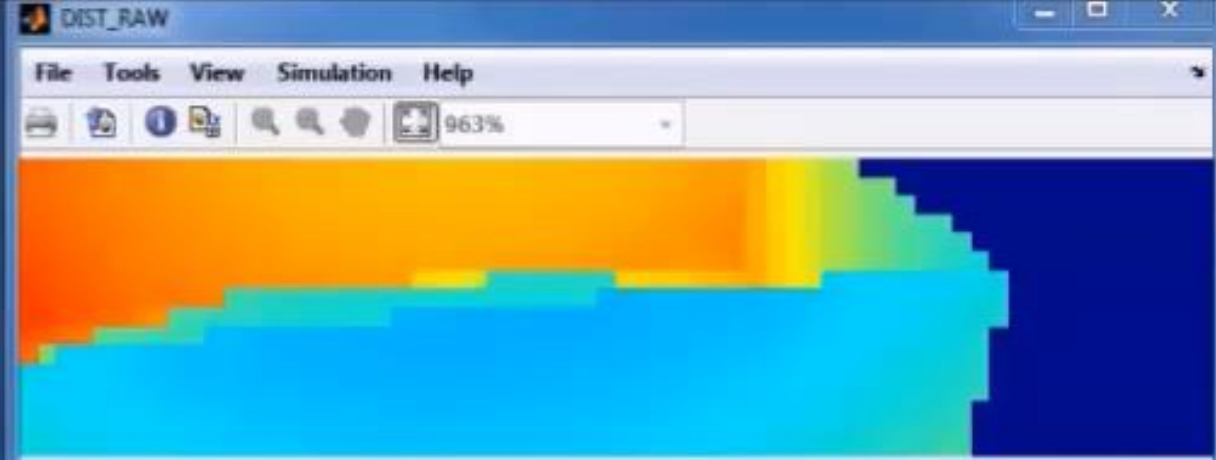
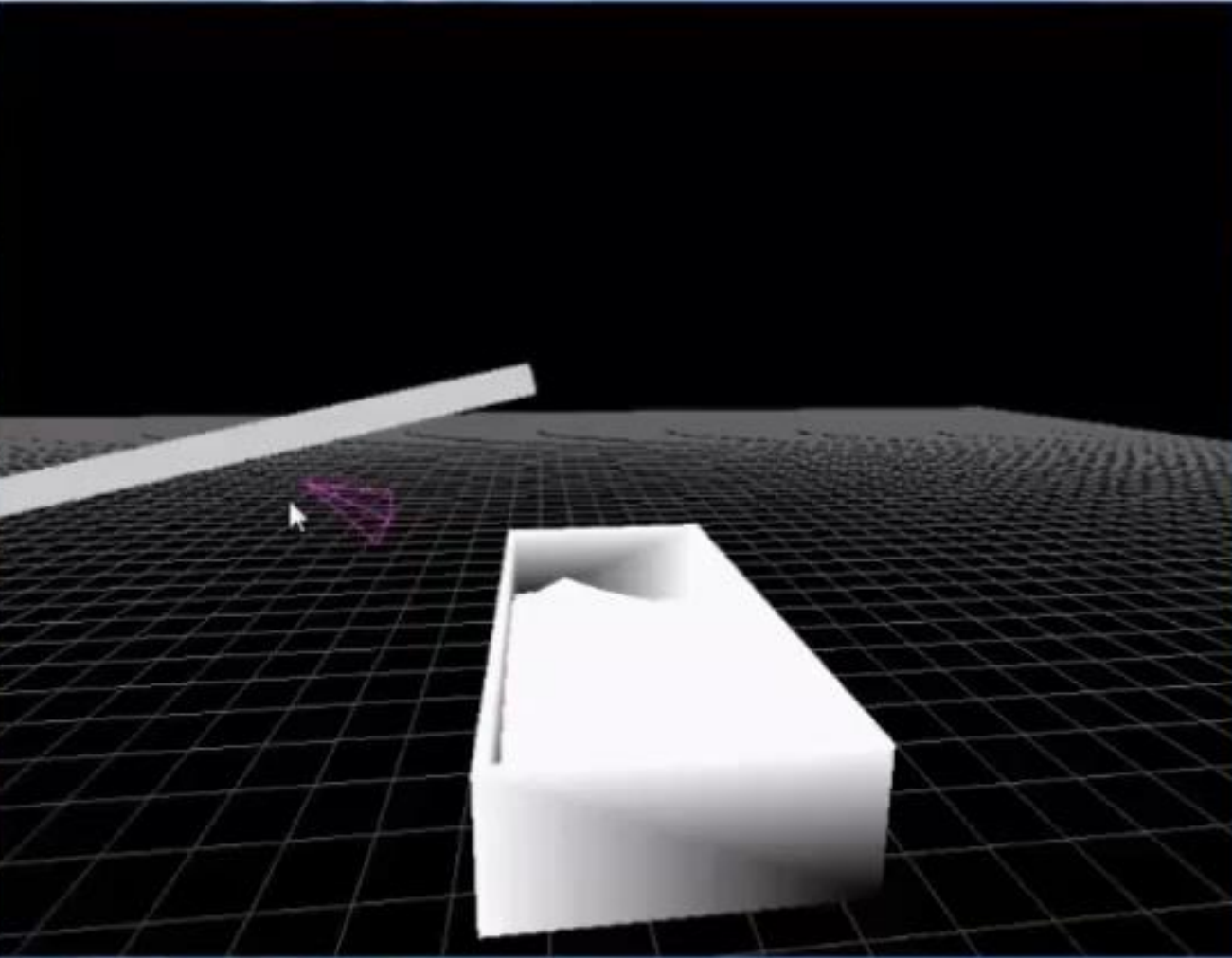

Autonomous Trailer Filling

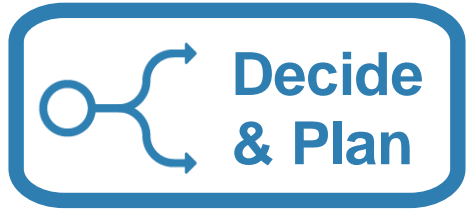
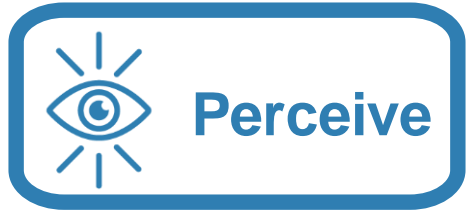

3D Cameras



Computer vision and controls algorithms

Embedded Platform
MPC5121e



- User Input
- Visualization

CAN

Actuators



ECU

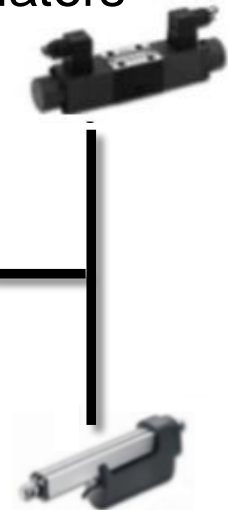

Autonomous Trailer Filling

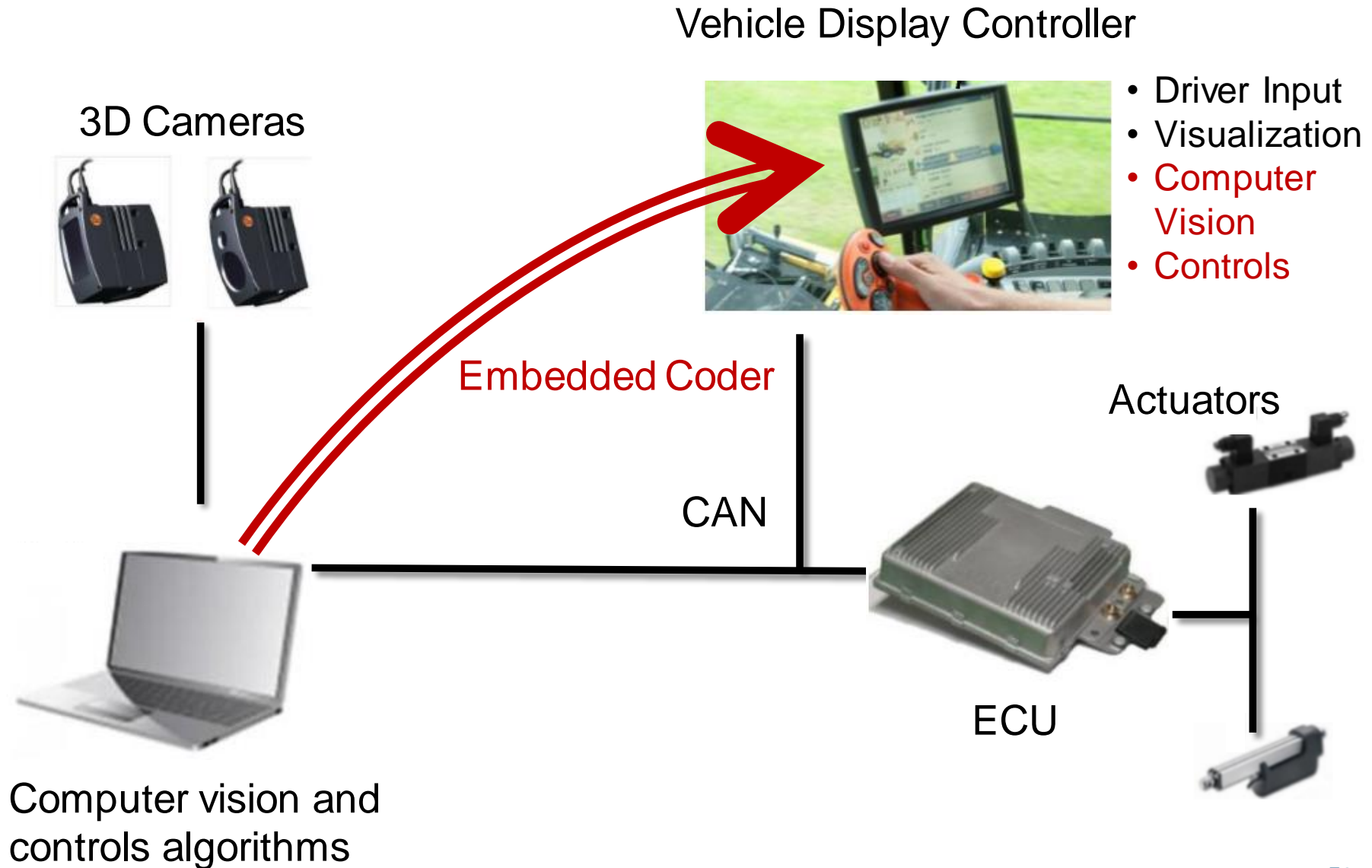
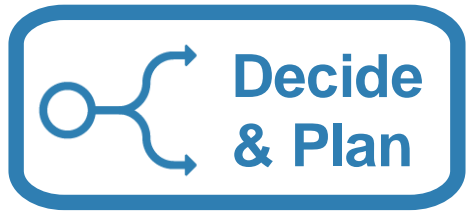
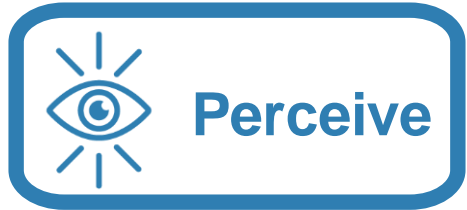

How will you put it into production?

- Embedded Systems
- IT Systems
- Cloud
- Desktop Apps



Investments in Model-Based Design

Efficient code generation

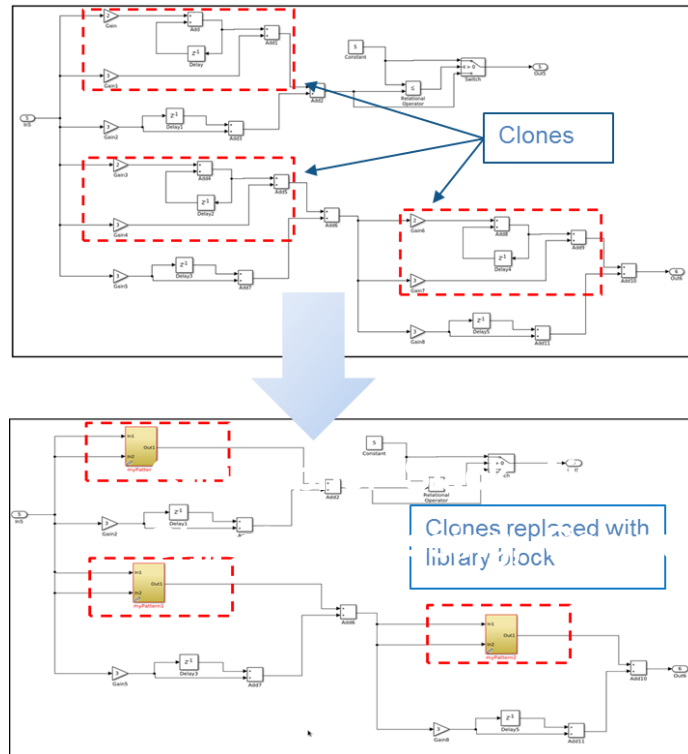

R2017a

Floating-point HDL code generation

R2016b

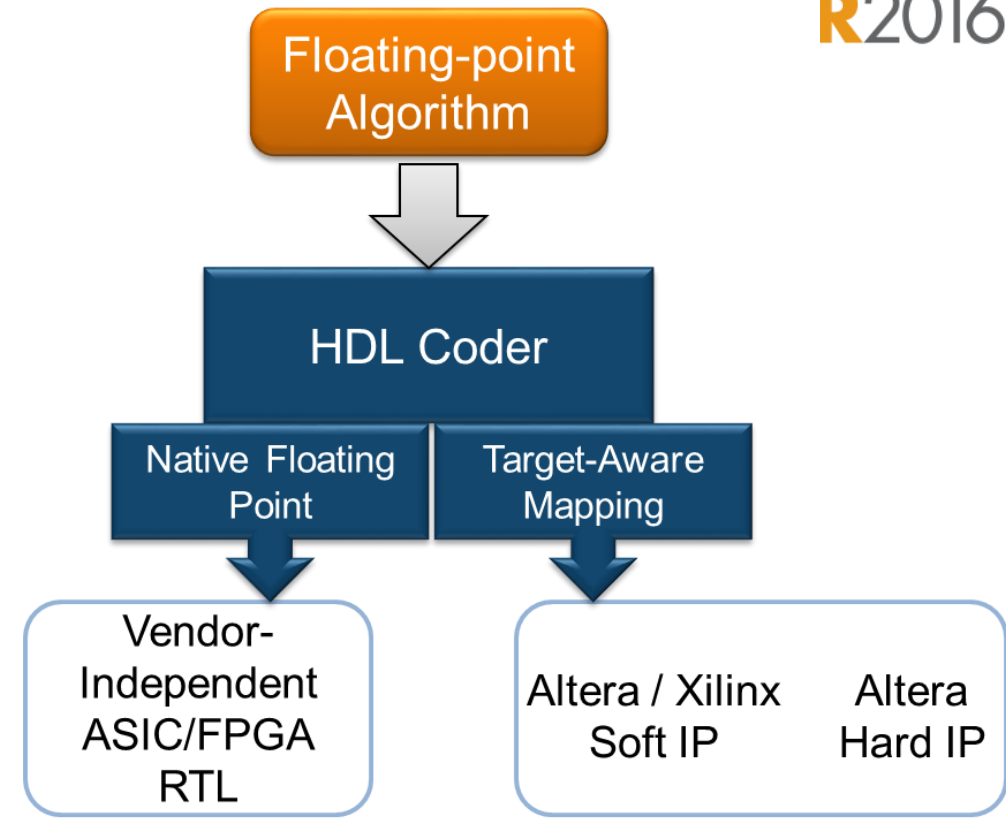

Investments in Model-Based Design

Floating-point HDL code generation

Efficient code generation

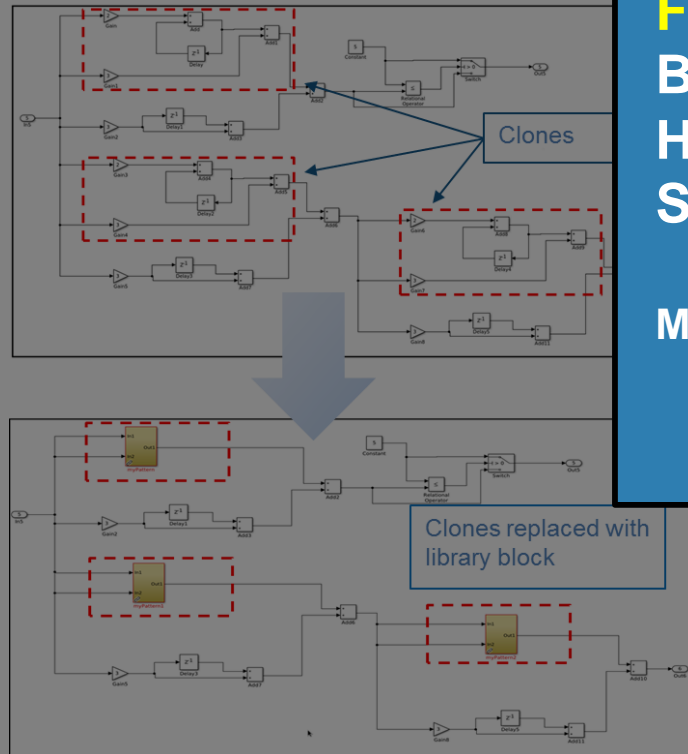

Find out more:
Better Than Hand: Generating Highly Optimized Code Using Simulink and Embedded Coder

Mark Danielsen, MathWorks

g-point
rithm

R2016b

Coder

Target-Aware Mapping

Vendor-Independent ASIC/FPGA RTL

Altera / Xilinx Soft IP

Altera Hard IP

R2017a

Investments in Model-Based Design

Code verification in support of CERT C standard



```

if (output v7 >= 0) {
    saved_values[output v7] = s8_ret;
    return s8_ret;
}
return reset_temp;

```

Assignment to element of static array (int 16): [-32 .. 112]
array size: 127
array index value: [0 .. 555]

CERT C	Description	Polyspace Code Prover
ARR30-C	Do not form or use out-of-bounds pointers or array subscripts	Array access out of bounds

Detect and fix standards compliance issues at design time

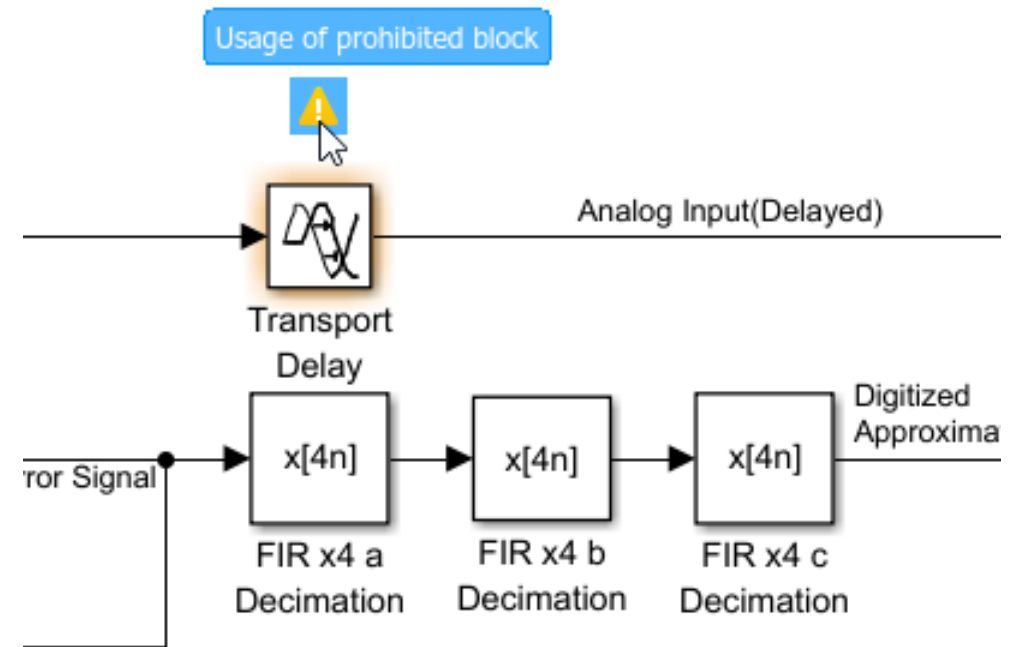

R2016b

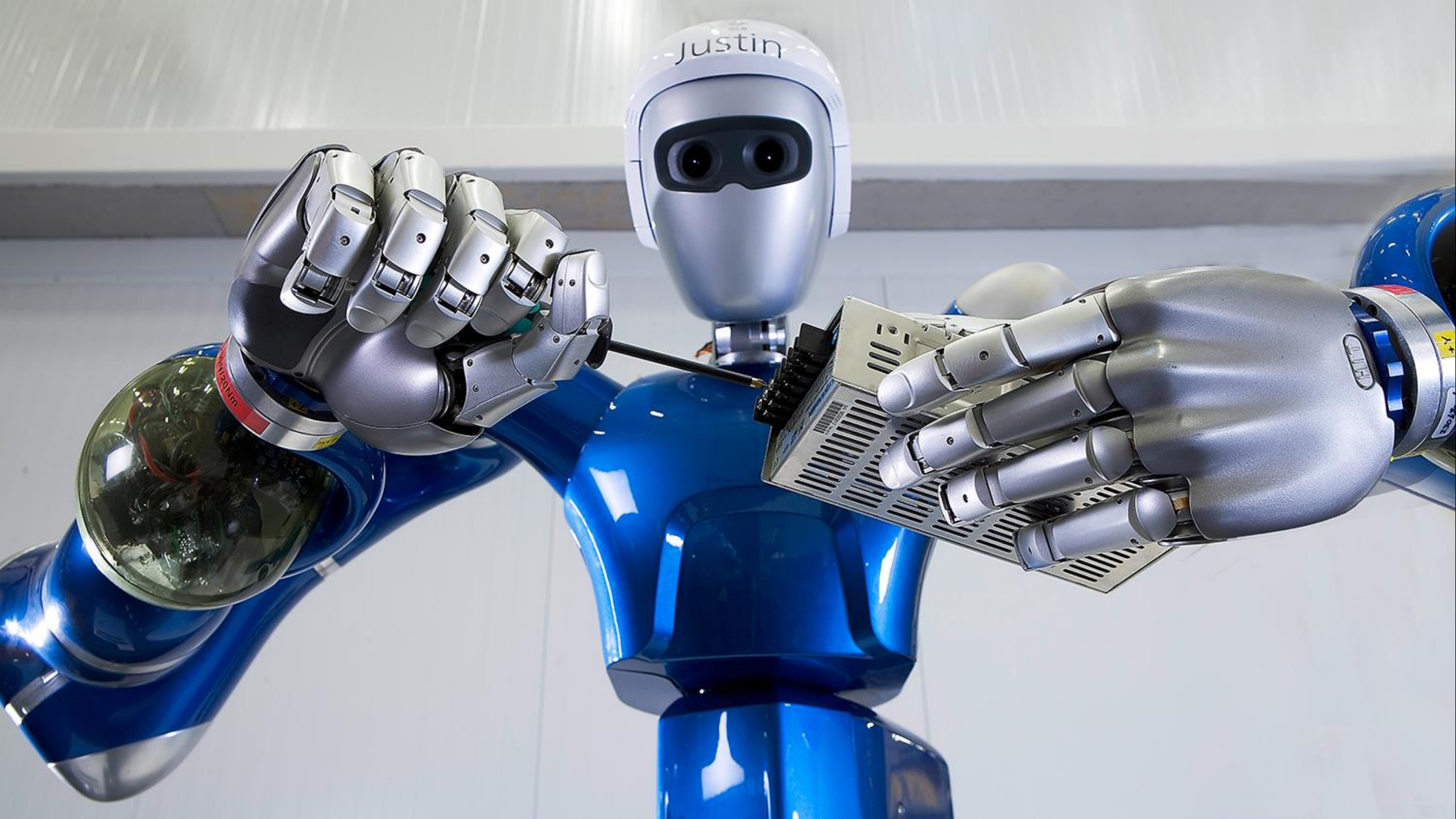

Justin





Capabilities of an Autonomous System

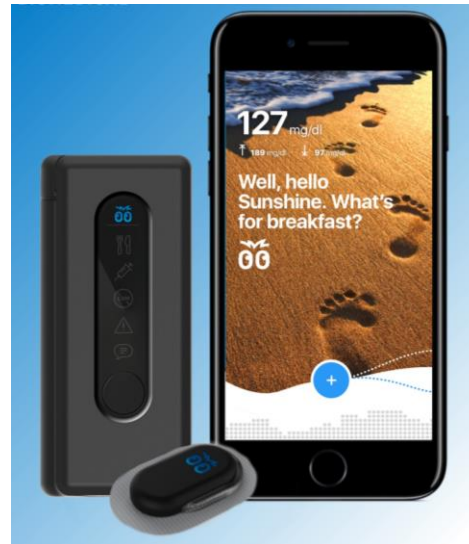
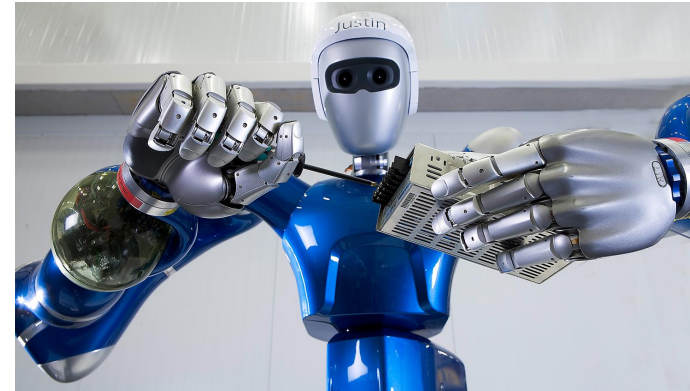
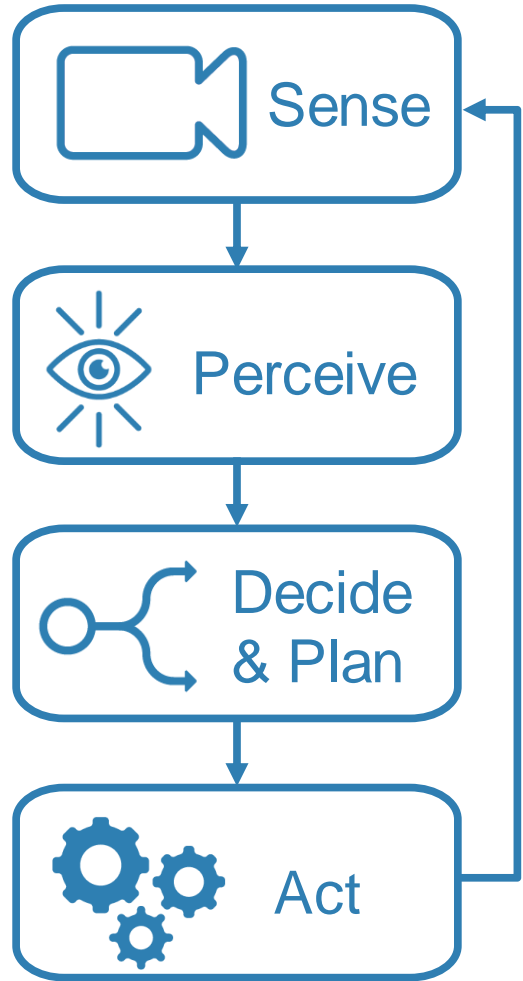

How to build an autonomous anything

Focus on Perception

- Look for autonomy in creative places
 - Do more than manually possible
-

Use the Best Predictors

- Data-driven
 - Model-driven
-

Get the Right Data

- Reduce to actionable data
 - Take advantage of Big Data
 - Use simulation to supplement available data
-

Flow to Production

- Address the architecture
- Leverage Model-Based Design for embedded
- Automate integration with enterprise IT systems

What is *your*
autonomous anything?