

MATLAB EXPO 2018

Novedades de MATLAB
y Simulink **R2017b** **R2018a**

David Pérez Moreno



Platform Productivity



**Getting your work
done faster**

Workflow Depth

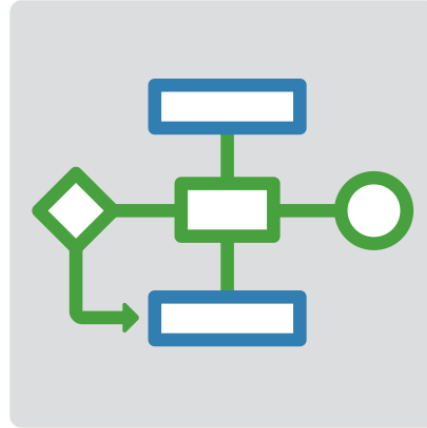

**Support for your
entire workflow**

Application Breadth

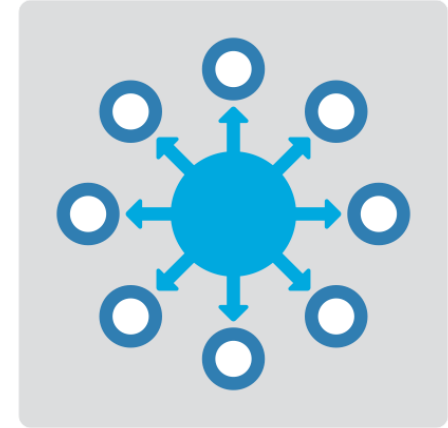

**Products for the
work you do**

Platform Productivity



Workflow Depth

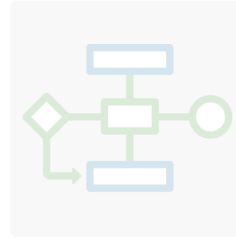

Application Breadth

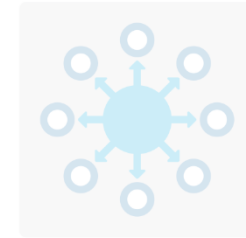

- **Create Your Designs Faster**
- **Simplify Analysis**
- **Simulate Faster and Scale Your Work**
- **Collaborate**

Create Your Designs Faster

The screenshot shows the MATLAB Live Editor interface. The main window displays a script titled "Explore and Analyze Storm Events". The script includes the following code:

```
clear
load prepEvents
data = timetable2table(data);
head(data)
```

Below the code, there is a section titled "Visualize with a Heatmap" with the following code:

```
bigFigure;
heatmap(data, 'state', 'weathercats');
xlabel('State')
ylabel('Storm Event')
title('Frequency of Events by Location')
```

The output of the script is displayed on the right side of the editor. It shows an 8x18 table of data:

	Time
1	22-Jul-2016
2	15-Jul-2016
3	15-Jul-2016
4	16-Jul-2016
5	15-Jul-2016
6	15-Jul-2016
7	15-Jul-2016
8	15-Jul-2016

Below the table is a heatmap visualization. The y-axis is labeled "Storm Event" and lists various weather categories such as Avalanche, Blizzard, Coastal Weather, Dense Fog, Drought, Dust Devil, Dust Storm, Extreme Heat, Flood, Freezing Fog, Frost/Freeze, Funnel Cloud, Hail, Heat, Heavy Rain, Hurricane, Ice Storm, Lightning, Sandstorm, Snow, Thunderstorm Wind, Tornado, Tropical Storm, and Waterspout. The x-axis represents different states. The heatmap shows the frequency of each storm event across the states.

MATLAB

Live Editor

Create Your Designs Faster

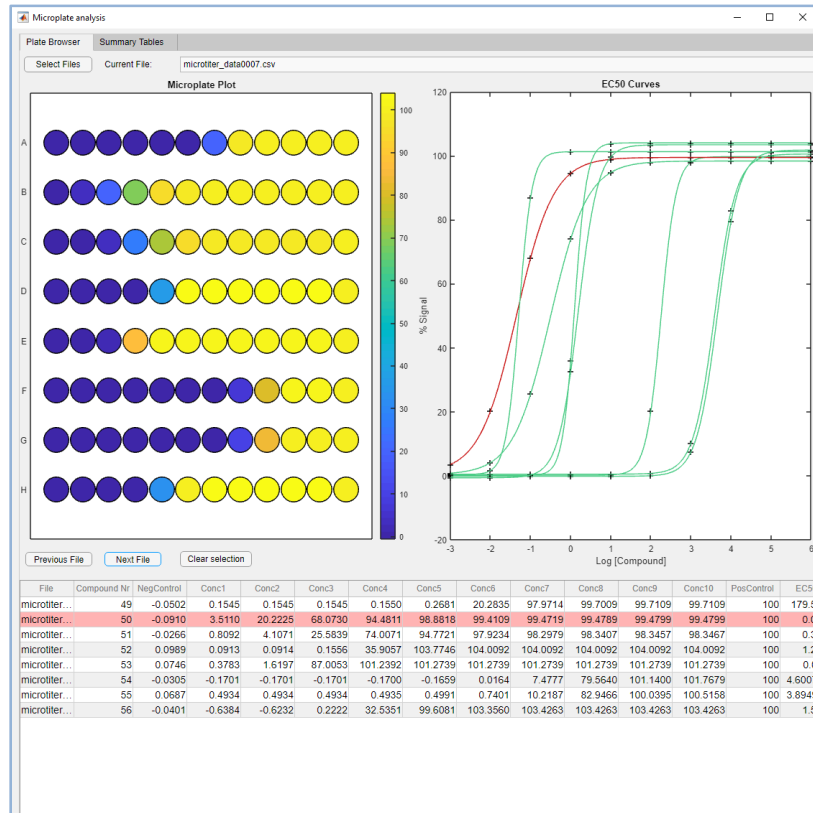

MATLAB
App Designer

The screenshot shows the MathWorks File Exchange interface. The main heading is 'File Exchange'. Below it is a thumbnail image of the migration tool. The title of the tool is 'GUIDE to App Designer Migration Tool for MATLAB', version 1.0 (15.1 KB) by MathWorks App Designer Team. The description states: 'Use the GUIDE to App Designer Migration tool to help transition your GUIDE apps to App Designer.'

Create Your Designs Faster

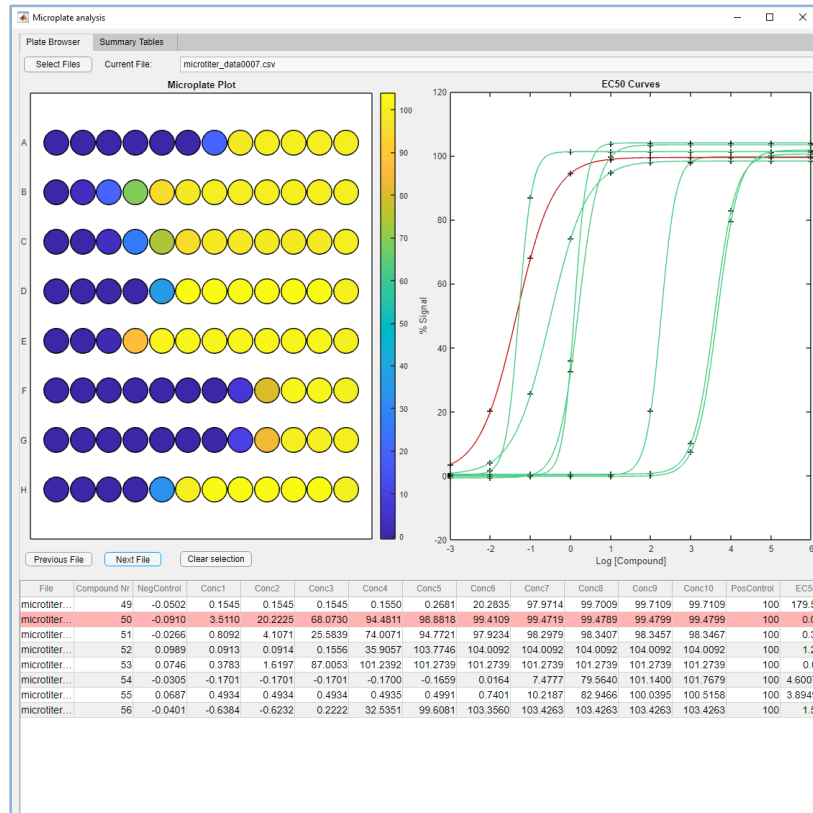

MATLAB

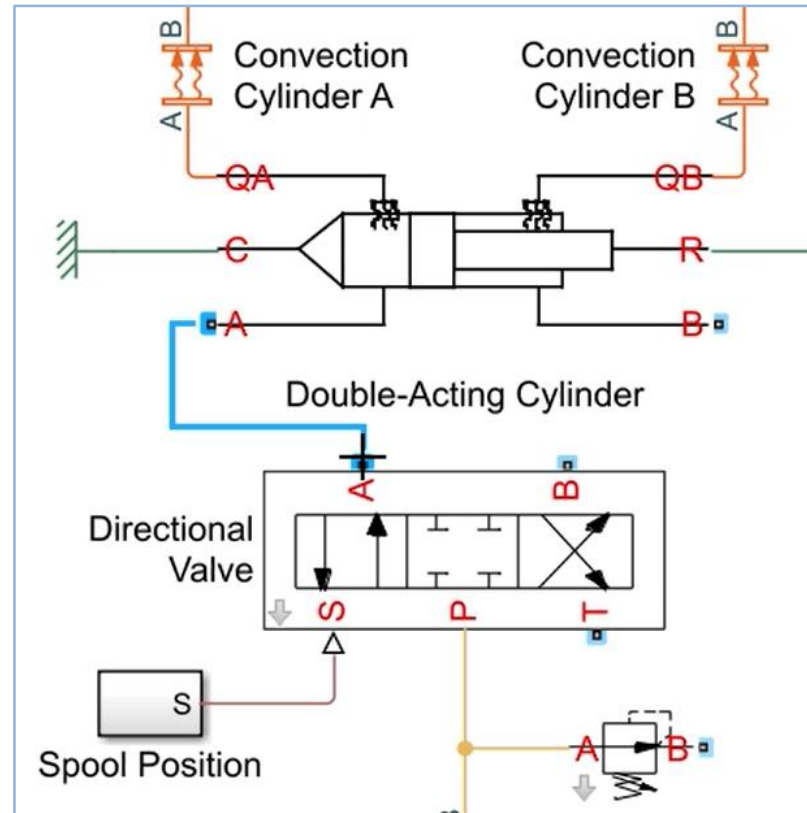

Simulink

Create Your Designs Faster

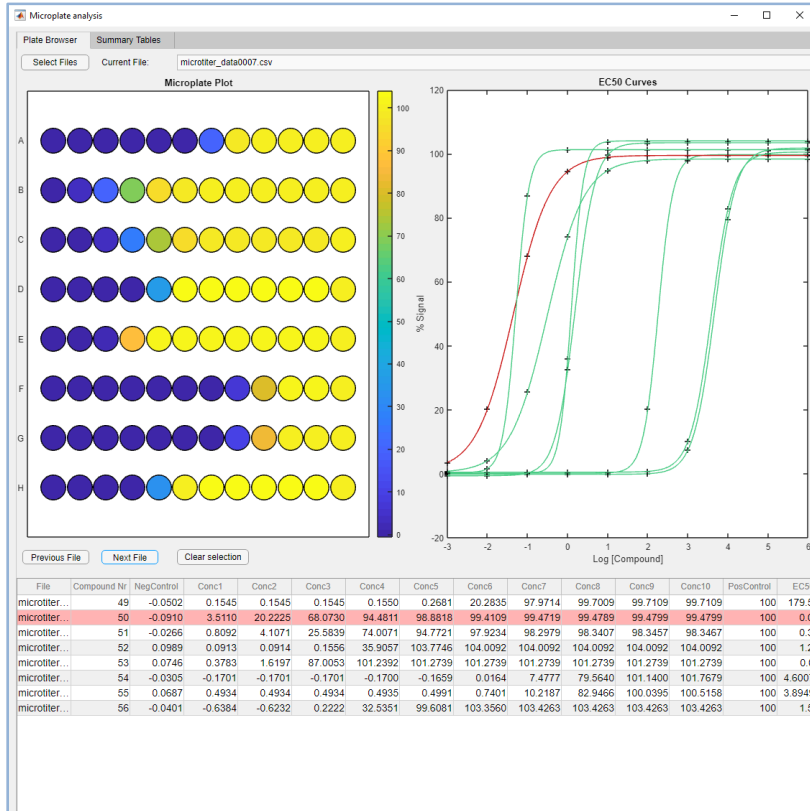

MATLAB

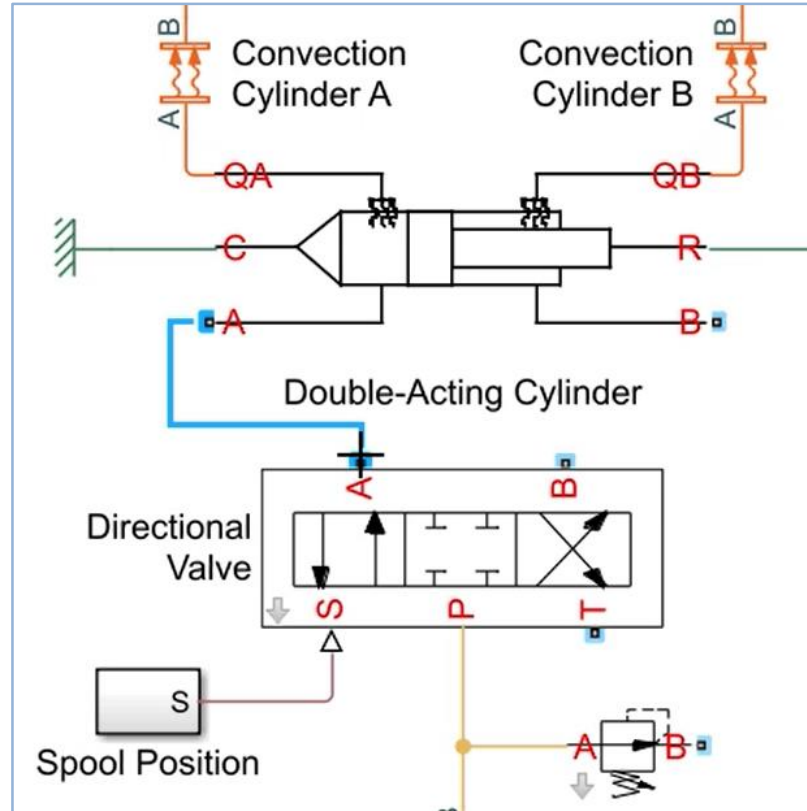

Simulink

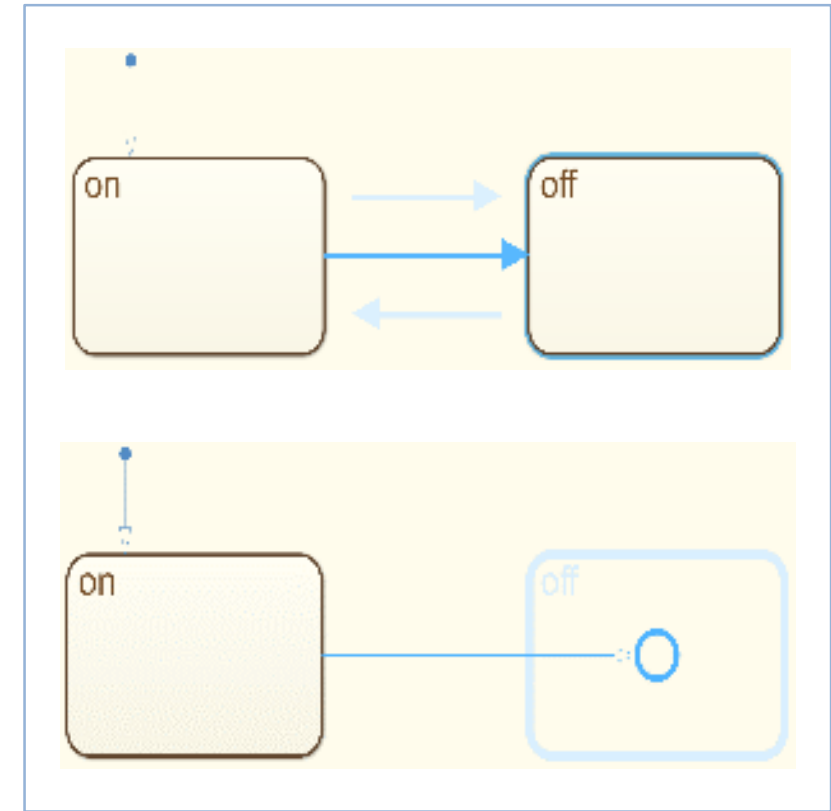

Stateflow

Simplify Analysis with Apps

These interactive applications automate common technical computing tasks

- **Econometric Modeler app**
 - Perform time series analysis, specification testing, modeling, and diagnostics
- **Analog Input Recorder app**
 - Acquire and visualize analog input signals
- **Wavelet Signal Denoiser app**
 - Visualize and denoise time series data

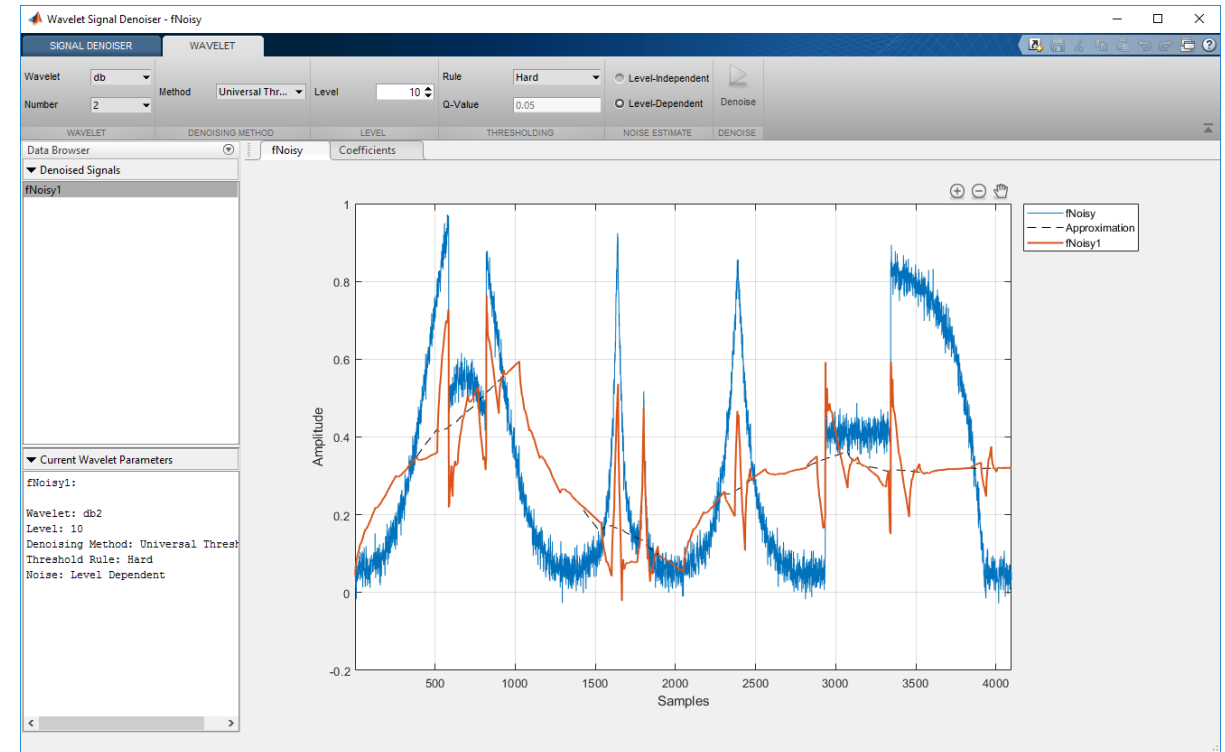

Simplify Analysis by Simulating at Wall Clock Speed

Slow down the simulation for easier model interactivity

- Especially for models controlled and monitored via Dashboard blocks and other displays
- Useful when model is connected to hardware

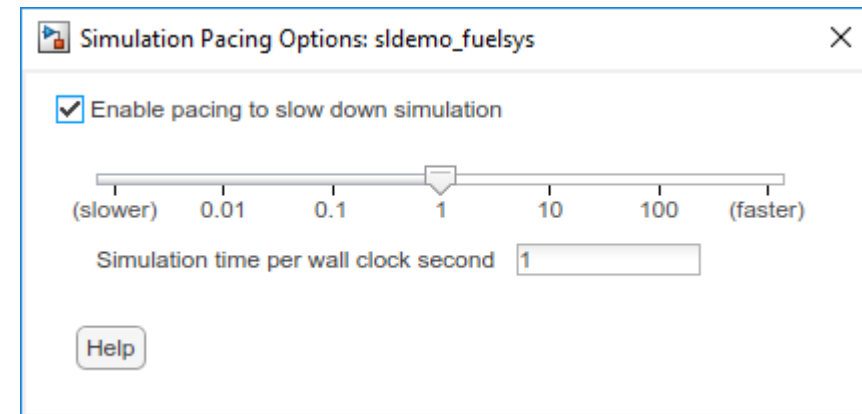

Scale Your Work

Use parallel computing to run multiple simulations faster

- Run multiple parallel simulations with `parsim`
- Monitor simulation status and progress in the Simulation Manager

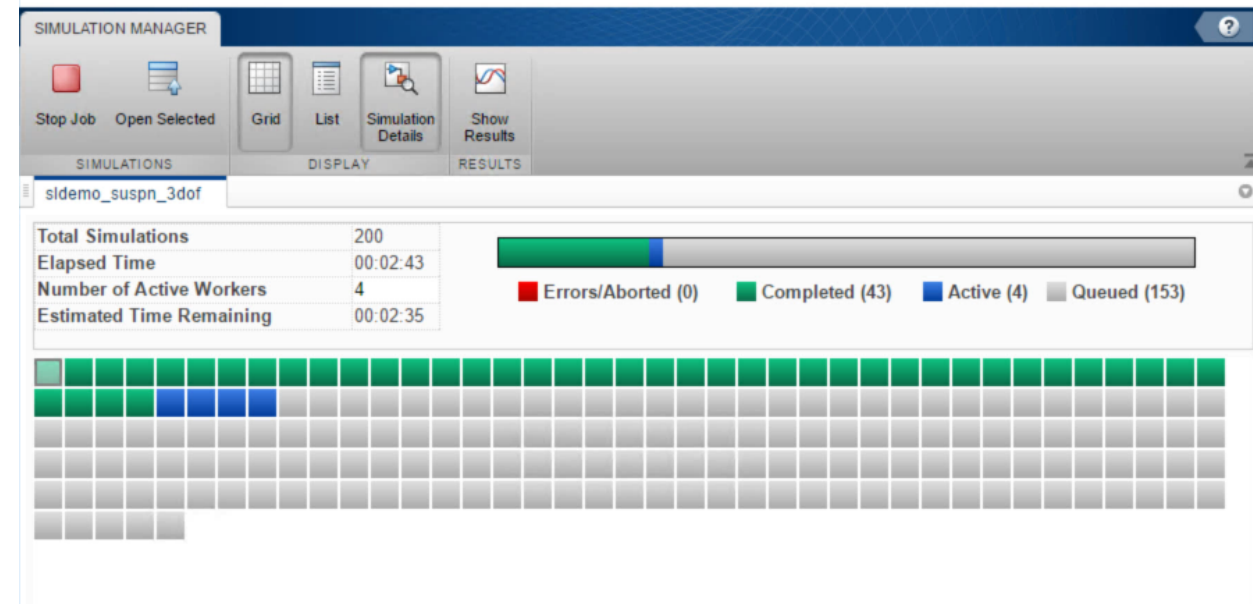
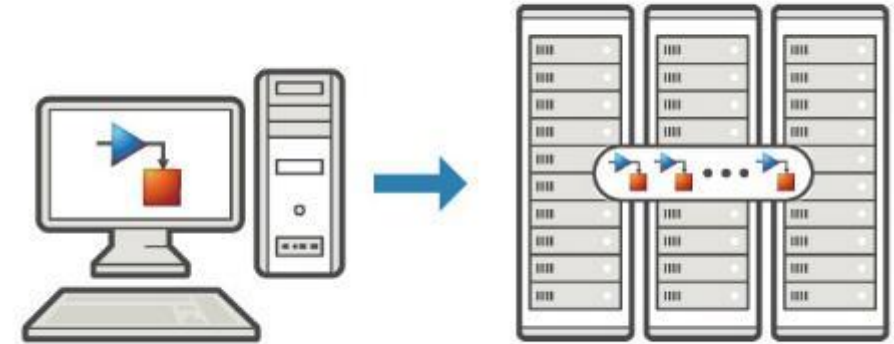

Scale Your Work

Use tall arrays to manipulate and analyze data that is too big to fit in memory

- Use familiar MATLAB functions and syntax
- Support for hundreds of functions
- Works with Spark + Hadoop clusters

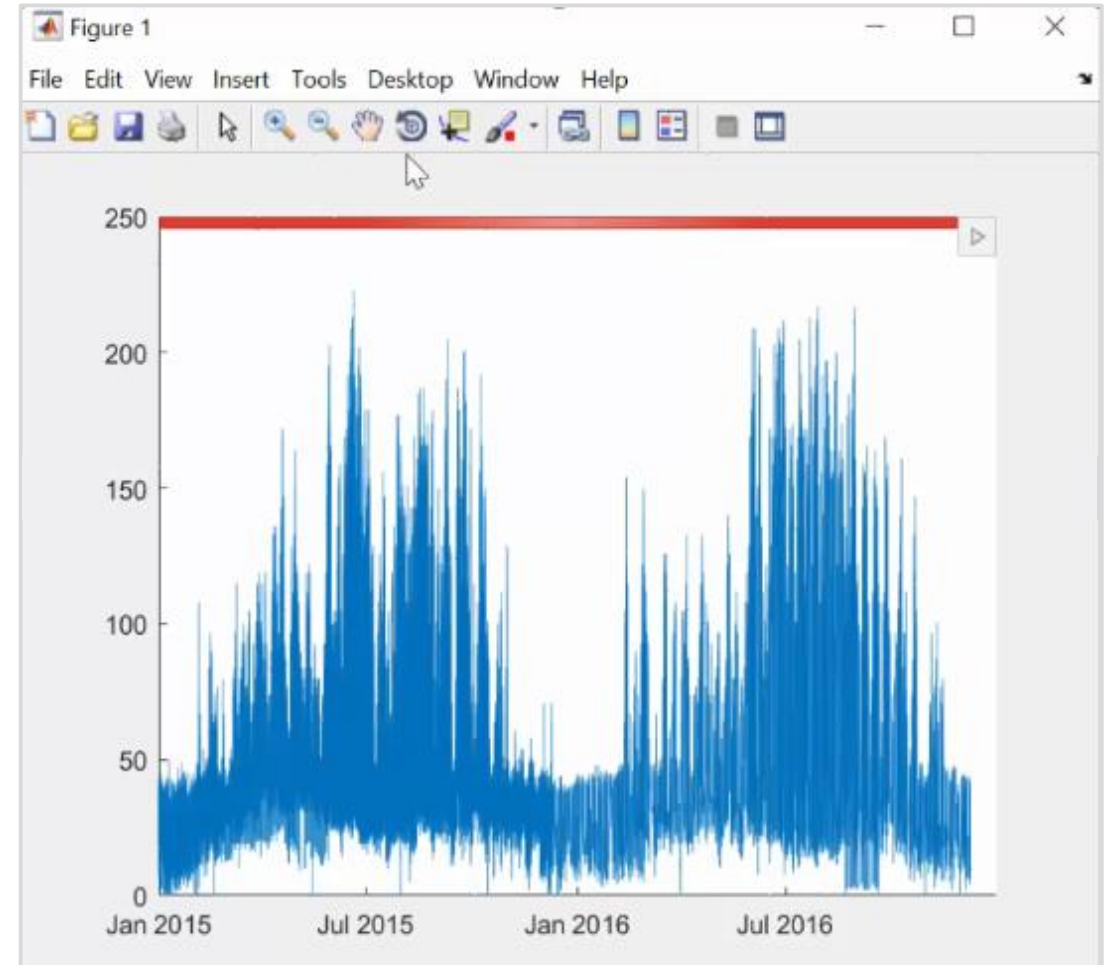

Simulate Faster

Redesigned execution engine runs MATLAB code faster

- All MATLAB code can now be JIT compiled
- MATLAB runs your code over twice as fast as it did just three years ago
- No need to change a single line of your code
- Increased speed of MATLAB startup in R2018a

Average Speedup in Customer Workflows

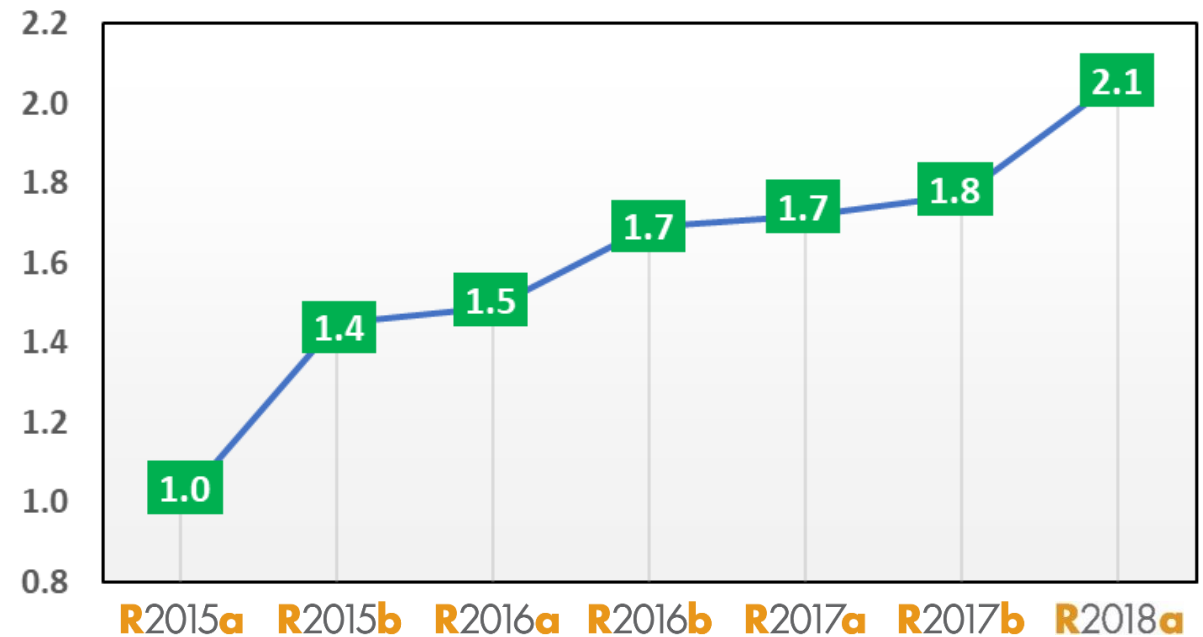

Team Collaboration

Use advanced software development features to manage, test, and integrate MATLAB code

MATLAB® Test Report

Timestamp: 04-Jan-2017 13:28:06
 Host: AH-SDE
 Platform: win64
 MATLAB Version: 9.1.0.441655 (R2016b)

Number of Tests: 17
 Testing Time: 0.4516 seconds

Overall Result: PASSED

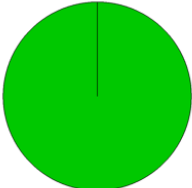

17 passed

Overview

C:\Documents\MATLAB\OOP\Blip\Demos\Extensions\UnitTest\Class\

BlipTests.BlipSizeLengthTests	0.1403 seconds
BlipTests.BlipSubsasnTests	0.1542 seconds
BlipTests.BlipSubsrefTests	0.1572 seconds

Details

C:\Documents\MATLAB\OOP\Blip\Demos\Extensions\UnitTest\Class\

BlipTests.BlipSizeLengthTests

- scalarBlipSize
The test passed.
Duration: 0.0863 seconds [\(Overview\)](#)
- vectorBlipSize
The test passed.
Duration: 0.0027 seconds [\(Overview\)](#)
- scalarBlipLength
The test passed.
Duration: 0.0044 seconds [\(Overview\)](#)

Team Collaboration

Use advanced software development features to manage, test, and integrate MATLAB code

Identify differences between model elements, Stateflow charts, and MATLAB Function blocks

MATLAB® Test Report

Timestamp: 04-Jan-2017 13:28:06
 Host: AH-SDE
 Platform: win64
 MATLAB Version: 9.1.0.441655 (R2016b)

Number of Tests: 17
 Testing Time: 0.4516 seconds

Overall Result: PASSED

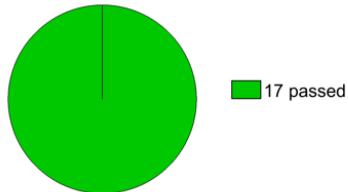

Overview

C:\Documents\MATLAB\OOP\Blip\Demos\Extensions\UnitTest\Class\

BlipTests.BlipSizeLengthTests	0.1403 seconds
BlipTests.BlipSubsasnTests	0.1542 seconds
BlipTests.BlipSubsrefTests	0.1572 seconds

Details

C:\Documents\MATLAB\OOP\Blip\Demos\Extensions\UnitTest\Class\

BlipTests.BlipSizeLengthTests

- scalarBlipSize**
The test passed.
Duration: 0.0863 seconds
- vectorBlipSize**
The test passed.
Duration: 0.0027 seconds
- scalarBlipLength**
The test passed.
Duration: 0.0044 seconds

Three-Way Merge - mine_slproject_f14.slx

MERGE

Previous Next Linked Scrolling Top Model Bottom Model Highlight Now Always Highlight in Models Filter Accept & Close

NAVIGATE HIGHLIGHT FILTER FINISH

Theirs: 340c64c37beb096a316e58a11358a6387d026b5f Base: e317566e2ad5f02f38f648e7d08716367a0fac Mine: mine_slproject_f14.slx

Simulink Pilot PilotGain Pilot:1 -> Bus Creator:1 PilotGain:1 Bus Creator:1

Model Configuration Sets Configuration Solver

Target: targetFile.slx

Simulink Pilot PilotGain Pilot:1 -> Bus Creator:1 PilotGain:1 Bus Creator:1

Model Configuration Sets Configuration Solver

Resolve remaining 1 changes

TYPE	UNRESOLVED	RESOLVED
Conflict	1	0
Conflicted manual merge	0	0
Manual merge	0	0
Automatic	0	4
Total	1	4

Platform Productivity



Workflow Depth

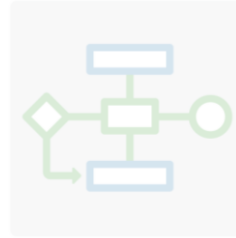

Application Breadth

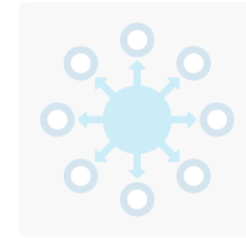

- **Create Your Designs Faster**
- **Simplify Analysis**
- **Simulate Faster and Scale Your Work**
- **Collaborate**

Platform Productivity



Workflow Depth

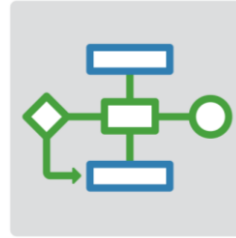

Application Breadth

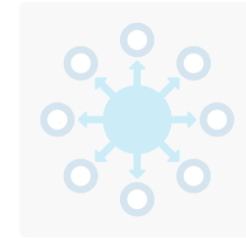

- **Deployment of MATLAB Algorithms and Applications**
- **Code Generation from Simulink Models**
- **Verification and Validation**

Deploy MATLAB Algorithms and Applications

Access Data



Sensors



Files



Databases

Analyze Data



Data exploration



Preprocessing



Domain-specific algorithms

Develop



AI model



Algorithm development



Modeling & simulation

Deploy



Desktop apps

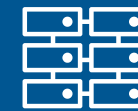

Enterprise systems

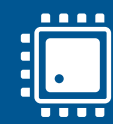

Embedded devices

Deploy MATLAB Algorithms and Applications

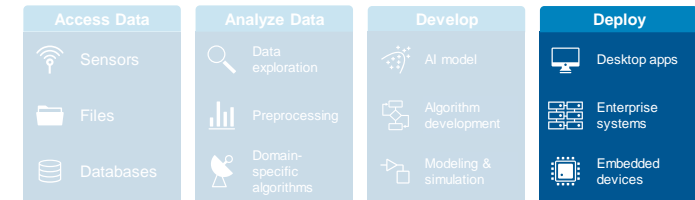

Share your work outside of MATLAB without having to recode your algorithms

- Standalone desktop applications
- Add-ins for Microsoft Excel
- Software components to integrate with other languages (*C/C++*, *.NET*, *Python*, *Java*)
- Software components for web and enterprise applications

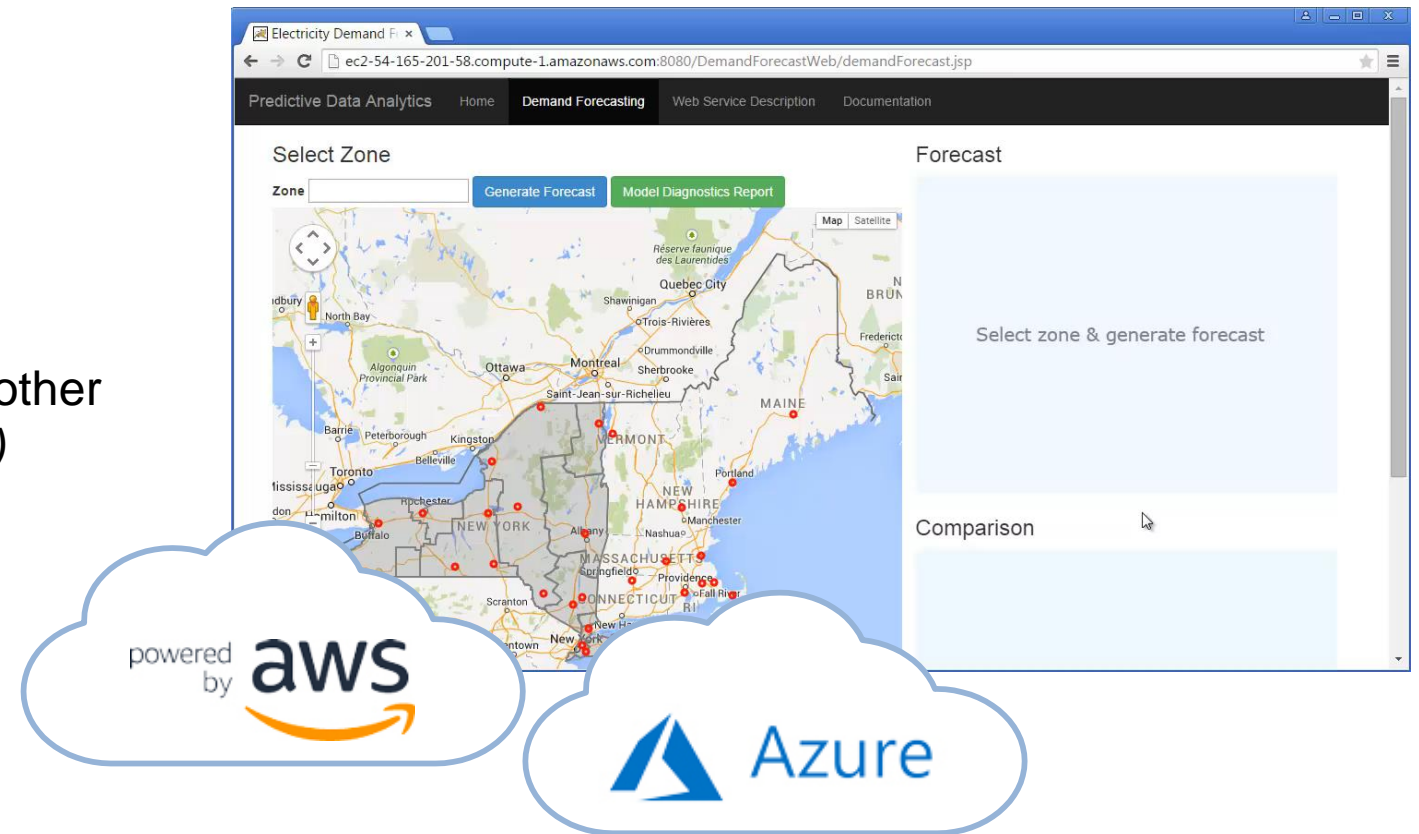

Deploy MATLAB Algorithms and Applications

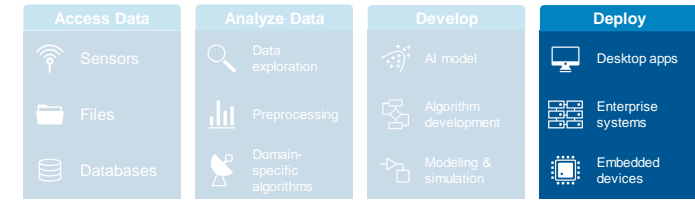

Share your work outside of MATLAB without having to recode your algorithms

- Standalone desktop applications
- Add-ins for Microsoft Excel
- Software components to integrate with other languages (*C/C++*, *.NET*, *Python*, *Java*)
- Software components for web and enterprise applications

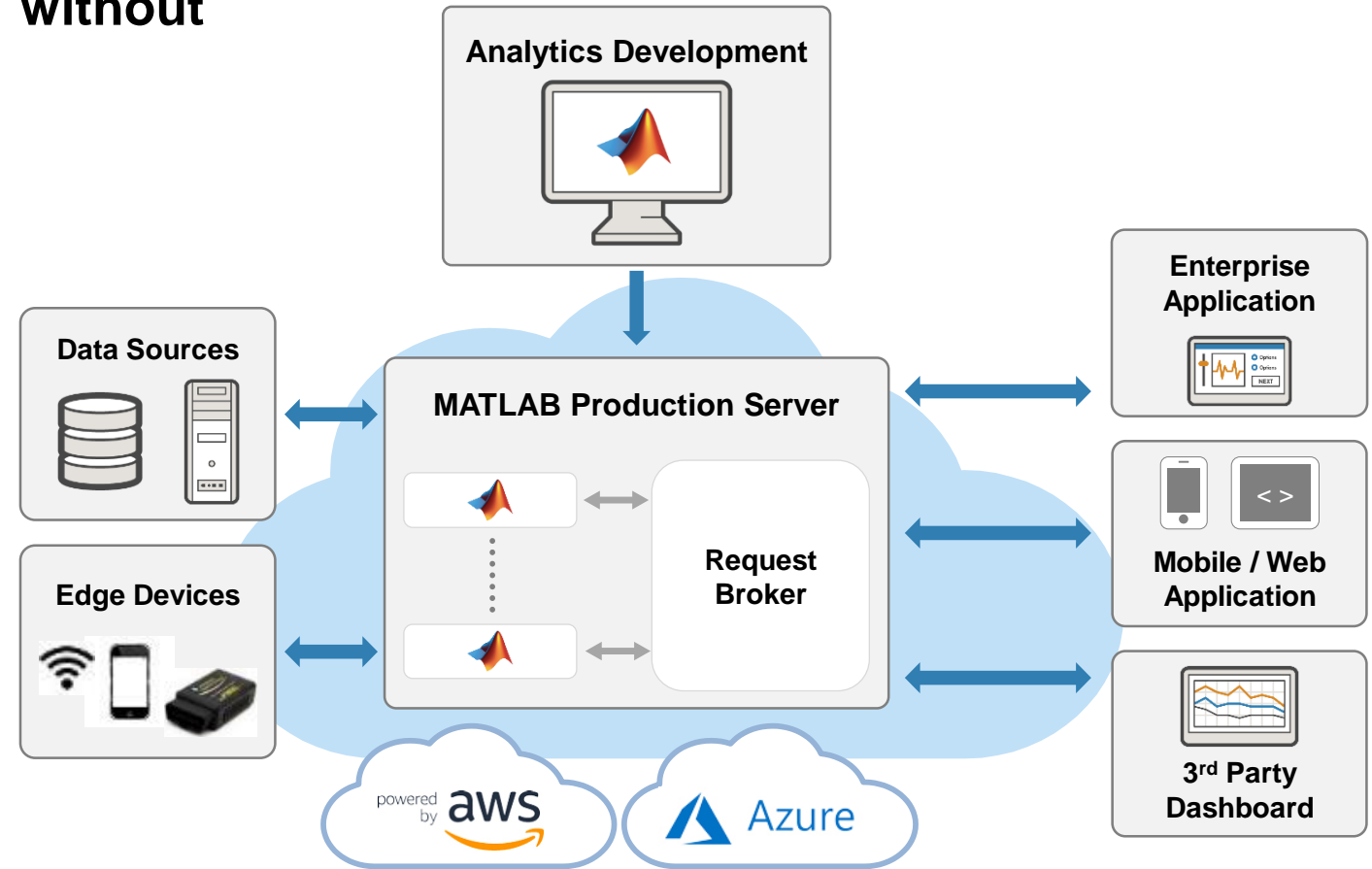

Deploy MATLAB Algorithms

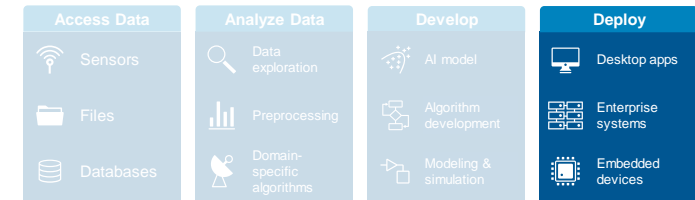

Deploy machine learning and deep learning models using automatically generated code

- Generate C code for predictive machine learning and deep learning models
- Generate optimized CUDA code for deep learning, embedded vision, and autonomous systems

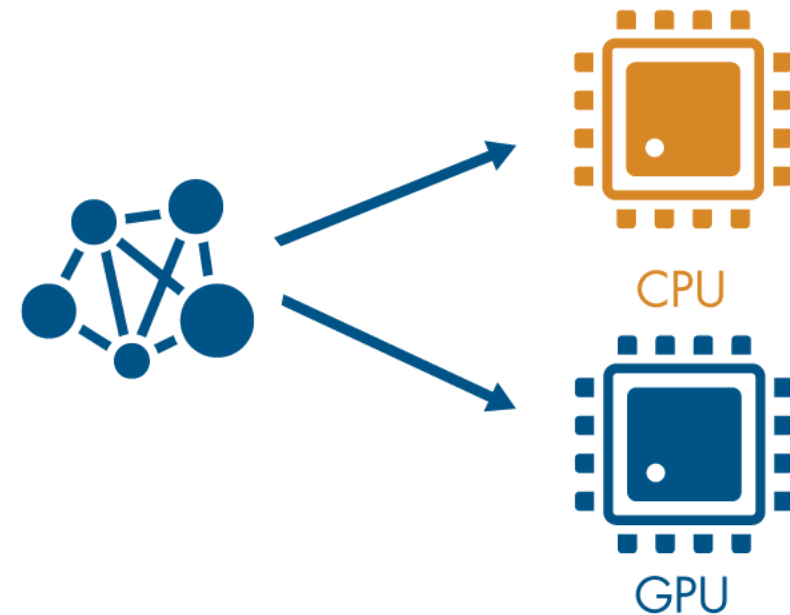

PID Control Tuning

Implement an embedded PID auto-tuning algorithm

- Automatically tune PID controller gains in real time against a physical plant
- No model of plant dynamics required
- Deploy the auto-tuning algorithm to embedded software using automatic code generation

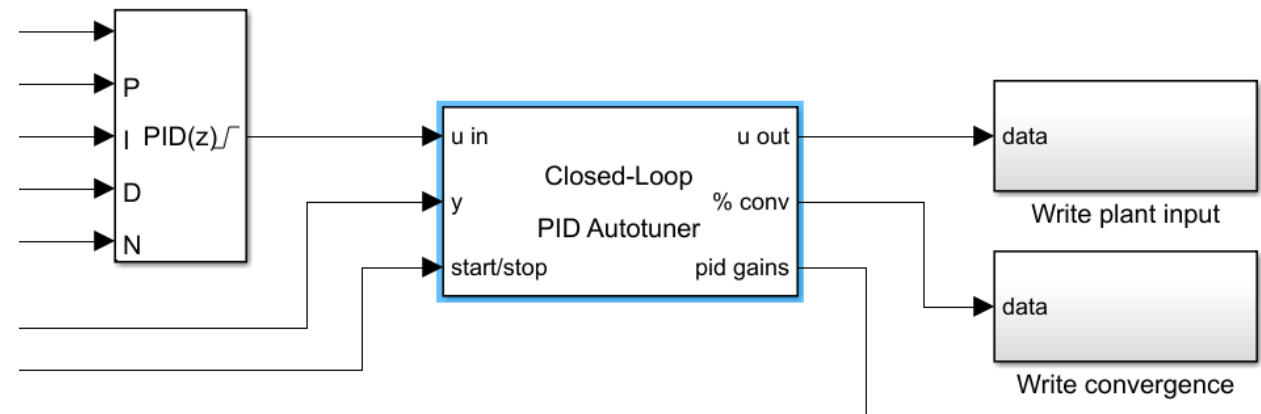

Prepare Your Model for Code Generation

Prepare model components
for code generation

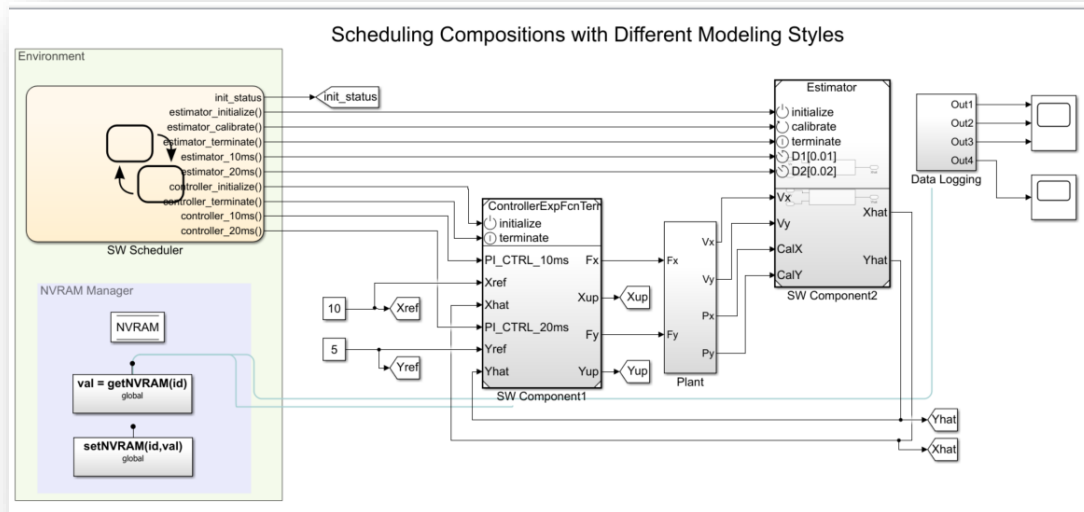

Prepare Your Model for Code Generation

Prepare model components for code generation

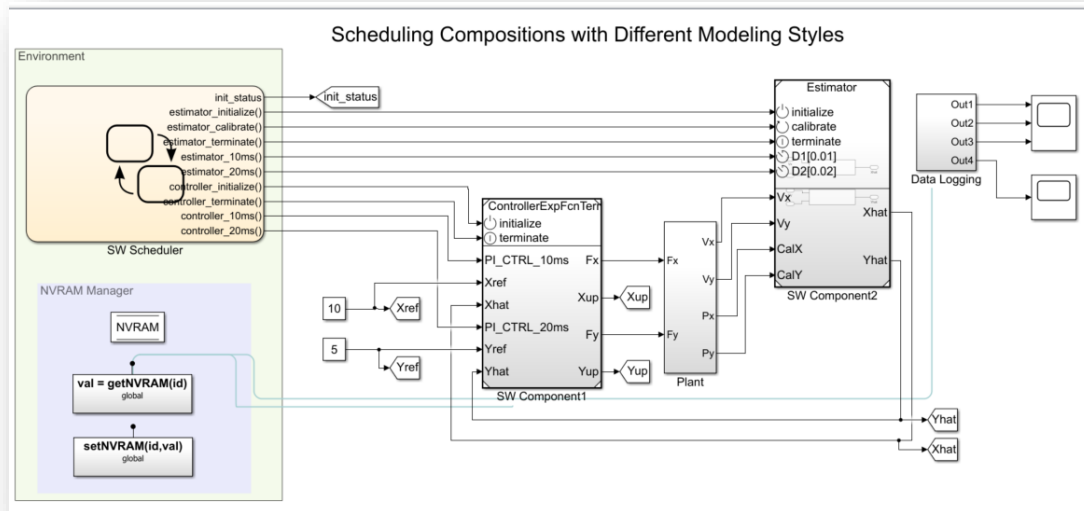

Prepare model data for code generation

The screenshot shows the FIXED-POINT TOOL interface. The 'System Under Design' is 'mpSRP_sub_codege...'. The 'Fixed-Point Advisor' is active, showing 'PREPARE SYSTEM' and 'COLLECT RANGES'. The 'MODEL HIERARCHY' shows a tree structure with 'Simulink Root', 'Data Objects', and 'mpSRP_sub_codegen_M'. The 'Results' table is visible, showing simulation ranges and data types for various subsystems.

Name	Run	CompiledDT	SpecifiedDT	ProposedDT	Accept Sim
SRP Subsystem...	Ranges(Double)	double	fixdt(1,13,11)	locked	0
SRP Subsystem...	Ranges(Double)	double	fixdt(1,13,11)	locked	0
SRP Subsystem...	Ranges(Double)	double	fixdt(1,17,15)	fixdt(0,17,22)	0

Visualization of Simulation Data

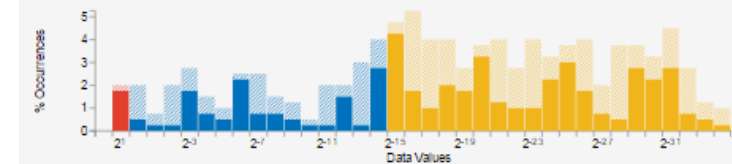

	Potential Overflows	In-Range	Potential Underflows
Positive Values	7	53	139
Negative Values	1	64	135

Number of times zero occurred: 0

Generate Code from Simulink Models

Access and define all the information in your model related to code generation

- View and define implementation data in one place
- View implementation details without model details
- Improve code performance and ease integration with other C code

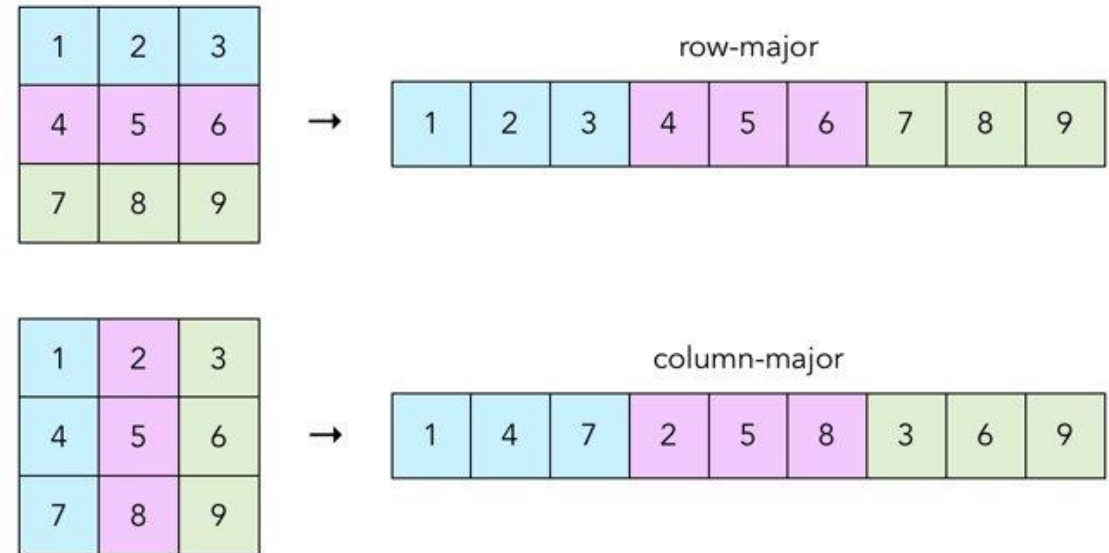

Row-major memory layout option

Connecting Your Design to Hardware

Connect directly to hardware with support packages

- Live streaming to and from hardware
- Run Simulink models on low-cost hardware, such as Arduino, Raspberry Pi, and LEGO
- Automatically generate code and run it on microprocessors, FPGAs, and more.



Arduino

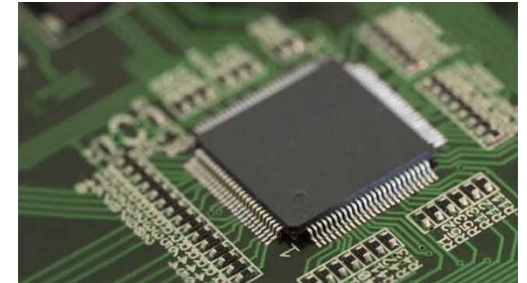

ARM Cortex



Raspberry Pi



Microsemi FPGA

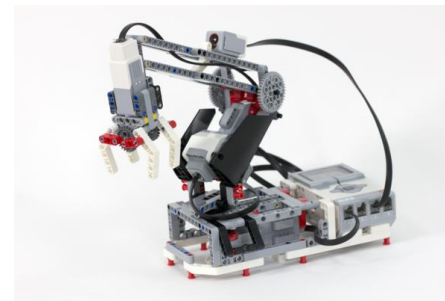

LEGO



ADALM-PLUTO

Deploying to FPGA or ASIC Hardware

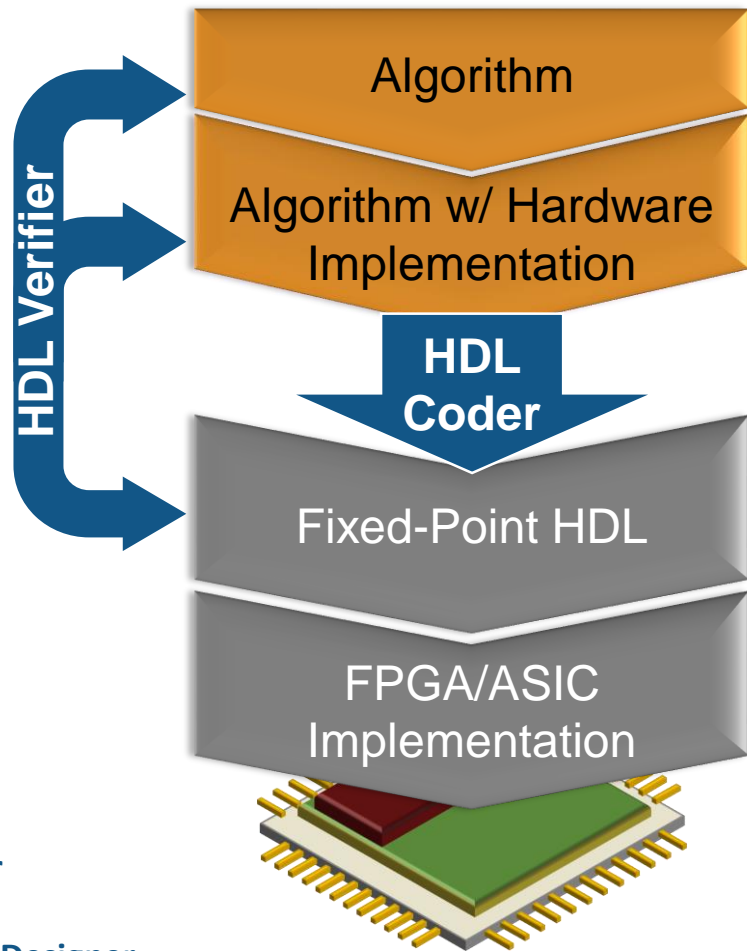

HDL Verifier
HDL Coder
Fixed-Point Designer
Vision HDL Toolbox
LTE HDL Toolbox

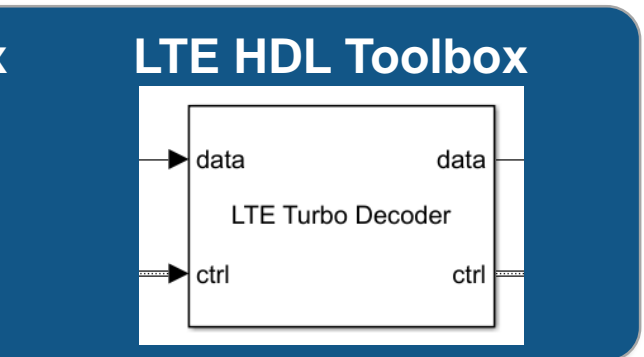
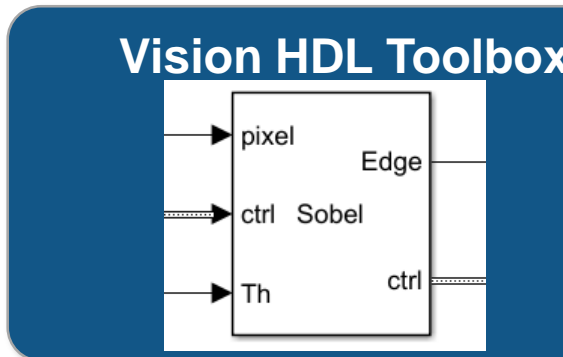
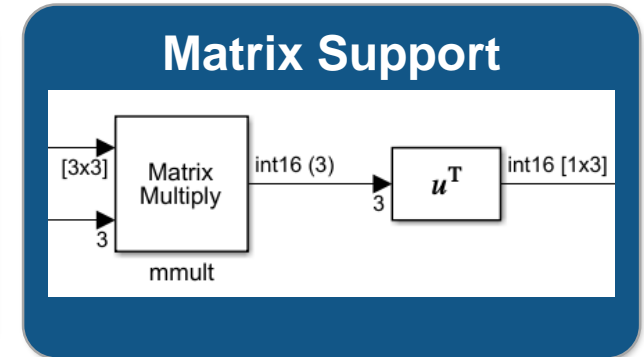
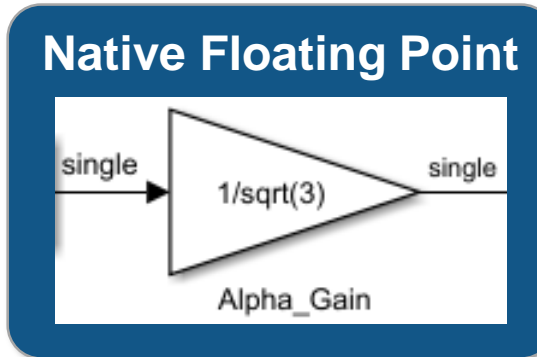

Verification and Validation

Products for the entire workflow

Simulink Requirements R2017b



Simulink Design Verifier

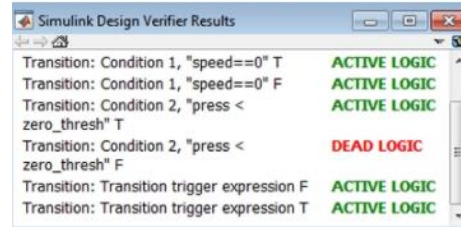

Simulink Check R2017b

- Modeling Standards for Secure Coding (CERT C, CWE, ISO/IEC TS 17961)
 - Check configuration parameters for secure coding standards
 - Check for blocks not recommended for C/C++ production code deployment
 - Check for blocks not recommended for secure coding standards
 - Check usage of Assignment blocks
 - Check for switch case expressions without a default case
 - Check for bitwise operations on signed integers
 - Check for equality and inequality operations on floating-point values
 - Check integer word lengths
 - Detect Dead Logic

Simulink Coverage R2017b

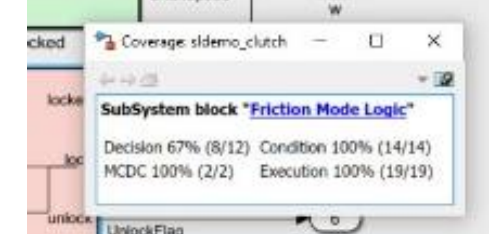

Simulink Test

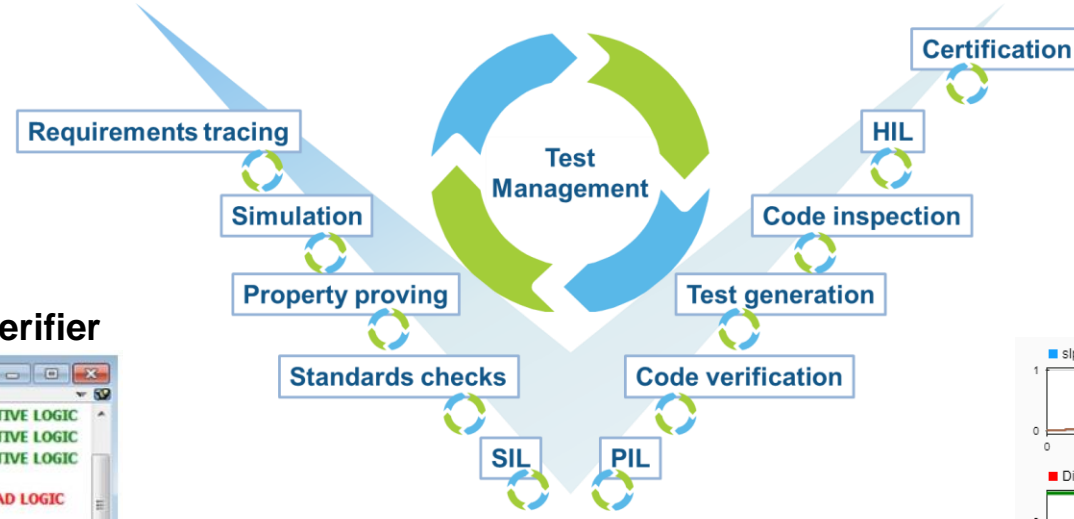
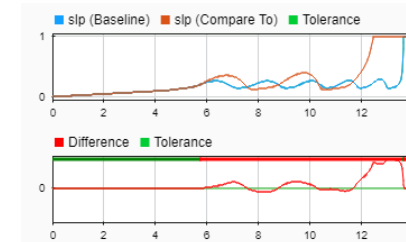

Polyspace

```

29  -----
30  *-----*
31  int_intdiv(int p)
32  {
33      int i;
34      int j = 1;
35
36      i = 1024;
37      return i;
    
```

Probable cause for 'Integer division by zero':

```

intdiv(1);
operator / on type int 32
left: 1024
right: 0
result: [-1024 .. 1024]
    
```

now supports
AUTOSAR
R2018a

Platform Productivity



Workflow Depth

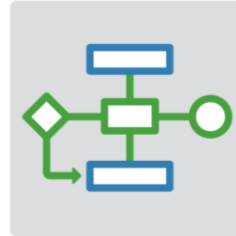

Application Breadth

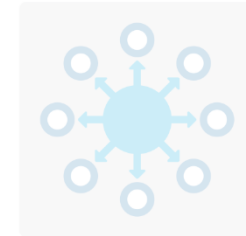

- **Deployment of MATLAB Algorithms and Applications**
- **Code Generation from Simulink Models**
- **Verification and Validation**

Platform Productivity



Workflow Depth

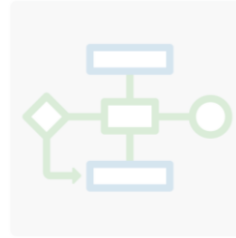

Application Breadth

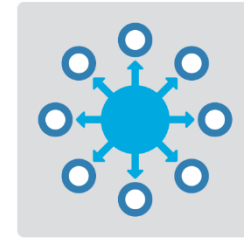

- **Autonomous Systems**
- **Wireless Communications**
- **Artificial Intelligence (AI)**

Designing Autonomous Systems

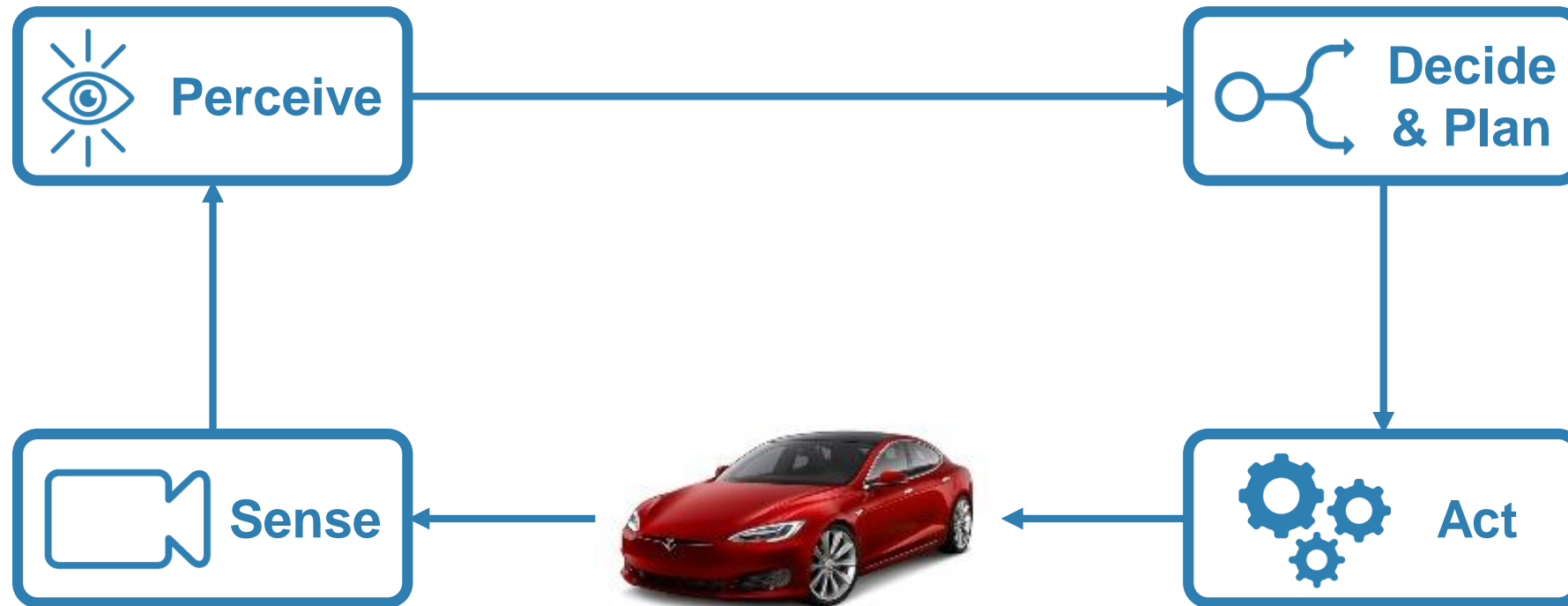

Designing Autonomous Systems

Mapping of environments using sensor data

- Segment and register lidar point clouds
- Lidar-Based SLAM: Localize robots and build map environments using lidar sensors

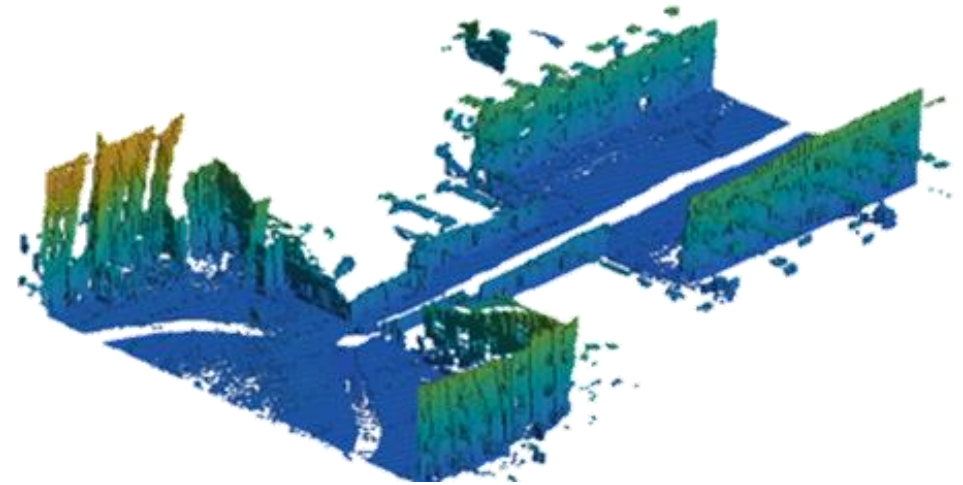
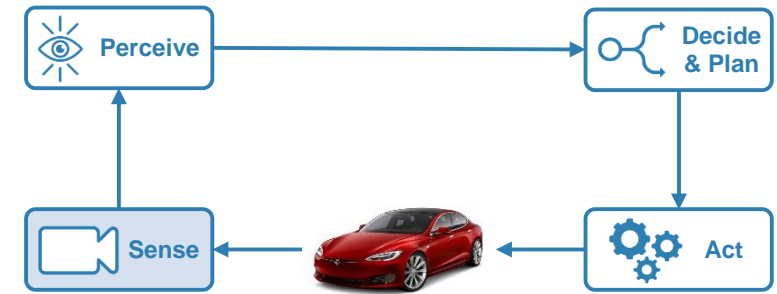

Designing Autonomous Systems

Understanding the environment using computer vision and deep learning techniques

- Object detection and tracking
- Semantic segmentation using deep learning

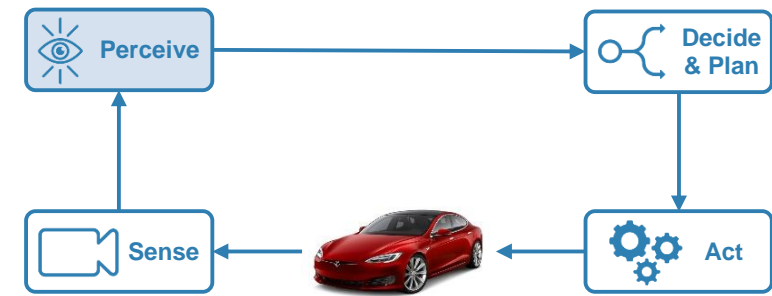

CamVid Database: Brostow, Gabriel J., Julien Fauqueur, and Roberto Cipolla. "Semantic object classes in video: A high-definition ground truth database." *Pattern Recognition Letters* Vol 30, Issue 2, 2009, pp 88-97.

Designing Autonomous Systems

Design synthetic driving scenarios to test controllers and sensor fusion algorithms

- Interactively design synthetic driving scenarios composed of roads and actors (*vehicles, pedestrians, etc.*)
- Generate visual and radar detections of actors

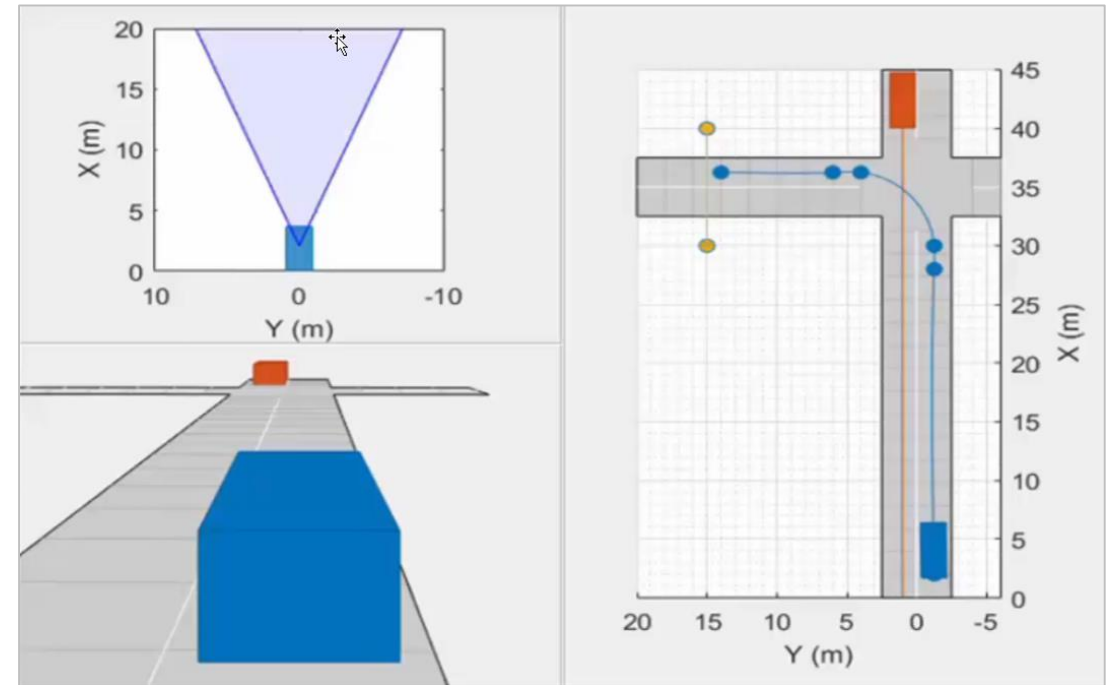
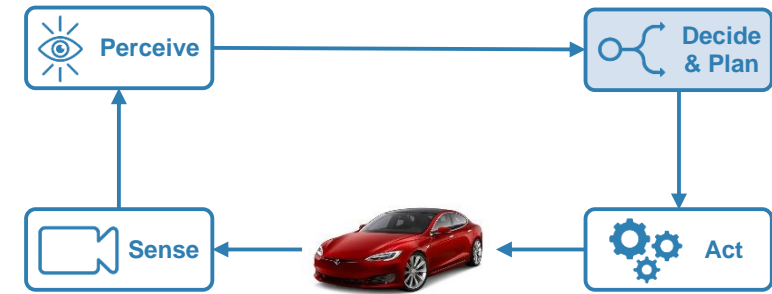

Driving Scenario Designer App

Designing Autonomous Systems

Model predictive control for adaptive cruise control and lane-keeping algorithms

- Use prebuilt blocks instead of starting from scratch
- Simplified application-specific interfaces for configuring model predictive controllers
- Flexibility to customize for your application

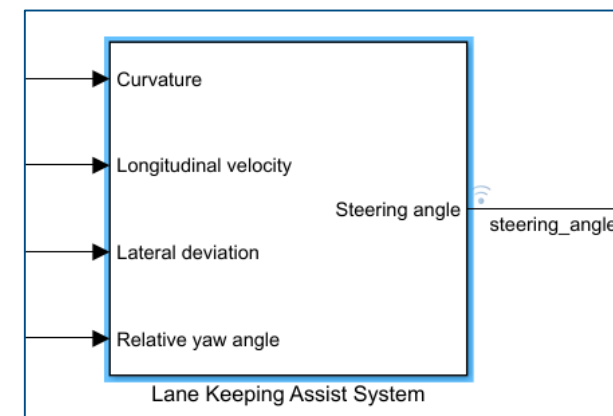
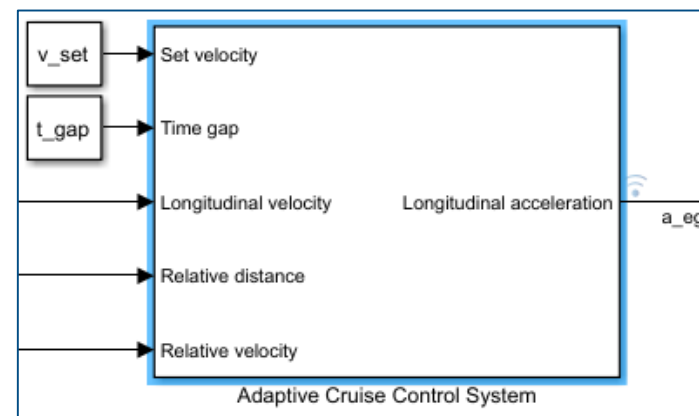
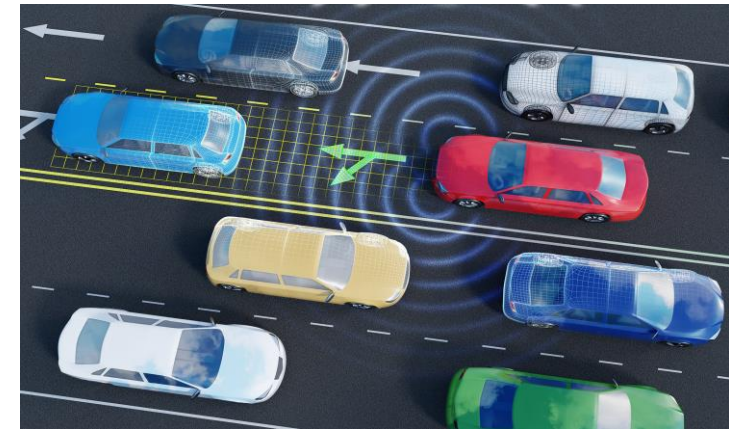
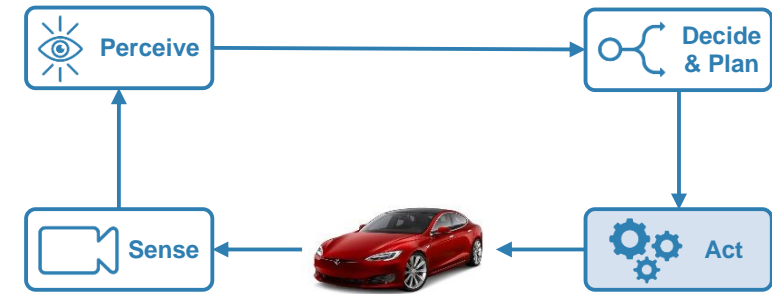

Full Vehicle Simulation

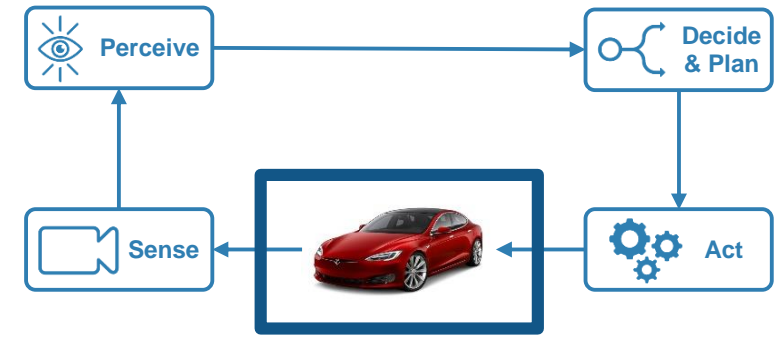

Ride & handling



Chassis controls



Automated Driving

Design with the Latest Wireless Standards



Lte™
Advanced
Pro



5G™



WiFi™
802.11ax



ZigBee®

NB-IoT

Model-Based Design for Wireless Communications

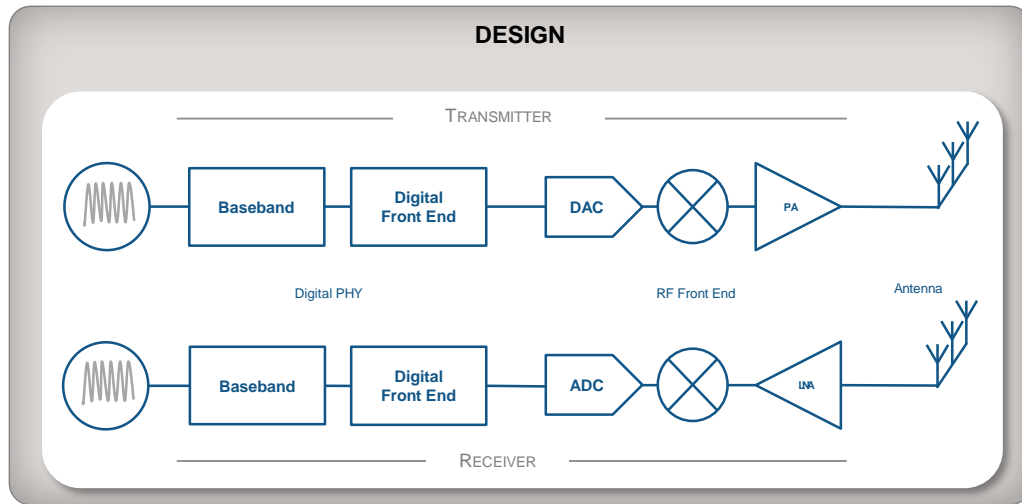

- Algorithm Design and Verification
- RF, Digital and Antenna Co-Design
- System Verification and Testing
- Rapid Prototyping and Production

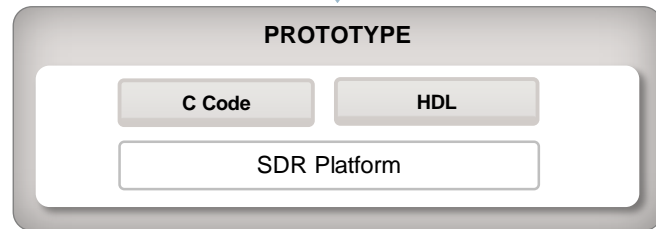

Code Generation and Verification

Fixed-Point Designer

HDL Coder

HDL Verifier

LTE HDL Toolbox **R2017b**

Embedded Coder

RF and Antenna Design and Prototyping

Use RF and Antenna models through your entire development cycle

- RF top-down design with RF Budget Analyzer app
- Adaptive hybrid beamforming and MIMO system modeling
- RF Power Amplifier modeling and DPD linearization
- RF propagation and 3D terrain visualization
- Design and fabrication of printed (PCB) antennas



From idea ...

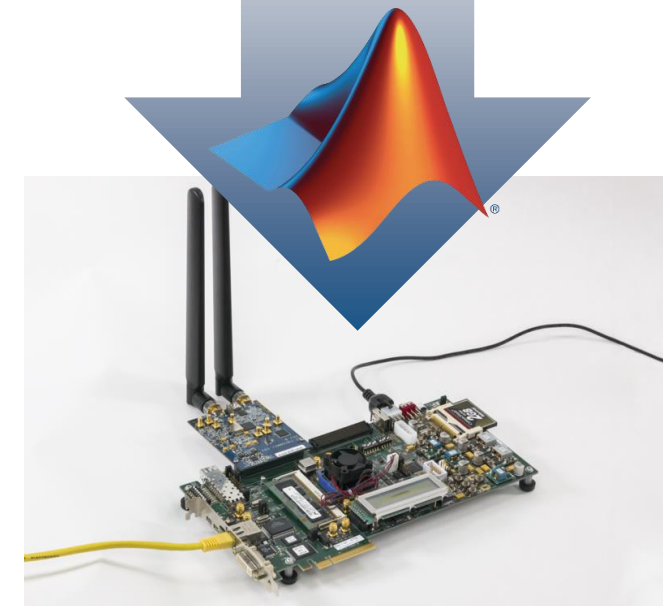

... to implementation

Model Moist Air Systems

Model HVAC and environmental control systems

- Model and simulate HVAC systems for a plant, such as a building, automobile, aircraft
- New library contains chambers, reservoirs, local restrictions, energy converters, sources and sensors
- Ensure acceptable temperature, pressure, humidity, condensation within the environment
- Note for Simscape in general: Run simulations about 5x faster with local solver option

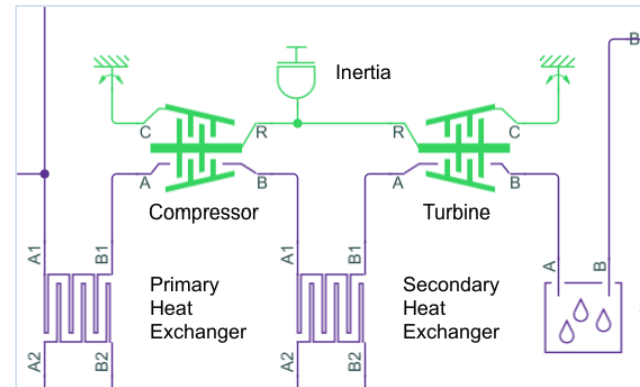

Artificial Intelligence

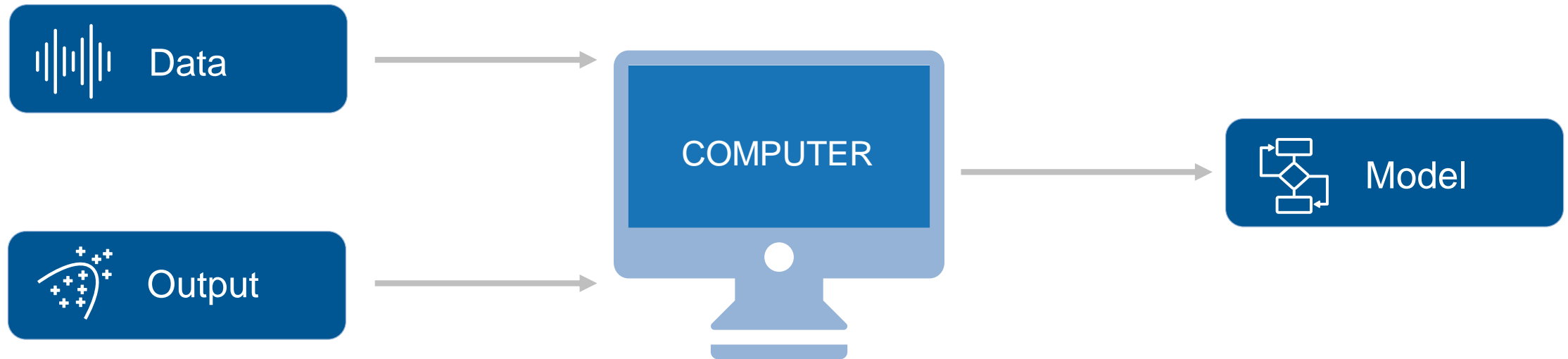

Text Analytics

Data

```
repairNotes = 617x1 string array
"PM SERVICE, CHECK TURN SIGNAL, CLUNKING NOISE"
"SERVICEROB,EXT,5604"
"NEED 4 PLOW PINS"
"INSTALL SPINNER ASSY"
"DONT START"
"DOG BONE PIN BROKEN"
"NEED SERVICE, CHECK BRAKES"
"HYD CAP CHECK ENGINE LIGHT ON"
"TARP VALVE STICKINGRIGHT SIDE MIRROR BRACKET B"
"HANDLES IN CAB LOOSE"
"NO PLOW LIGHTS"
"WILL NOT START"
```

Output



Model

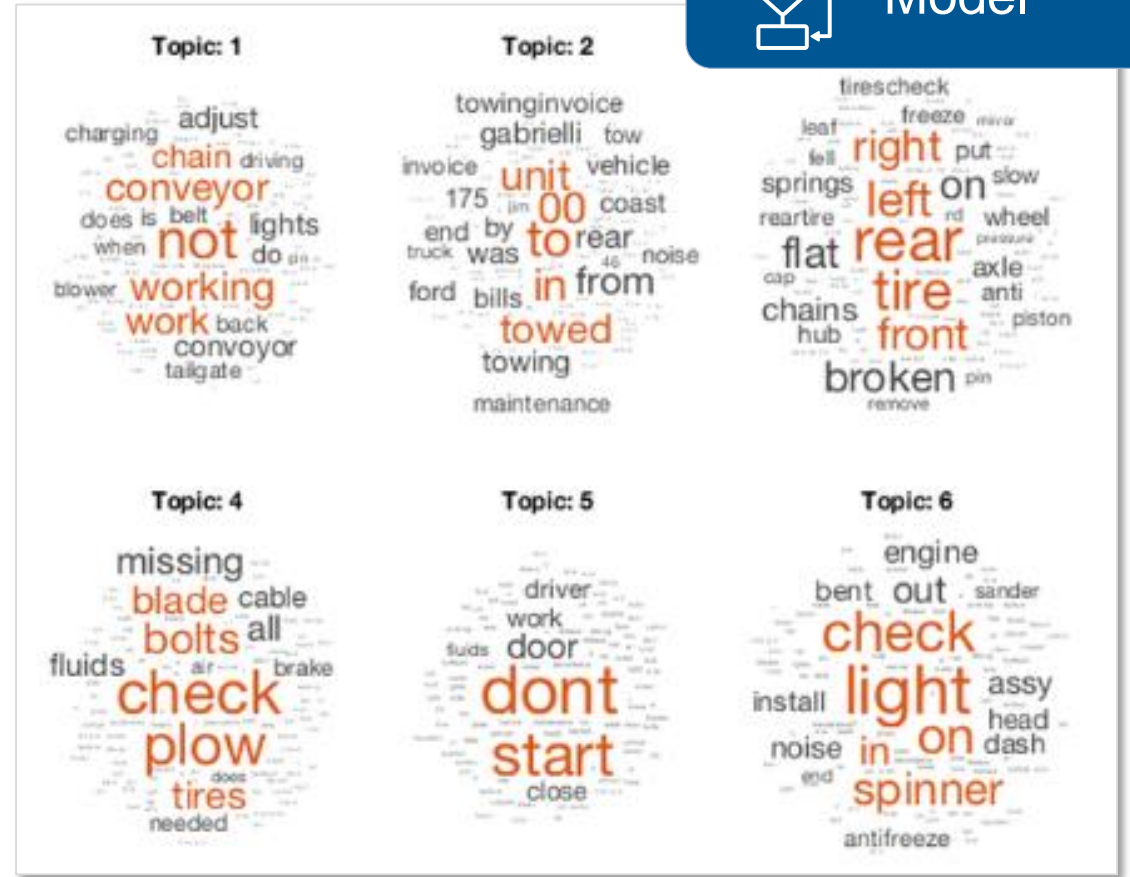

Text Analytics

Work with text from equipment logs and operator reports

- **Preprocess** raw text data by extracting, filtering, and splitting
- **Visualize** text using word clouds and text scatter plots
- **Develop** predictive models using built-in machine learning algorithms (LDA, LSA, word2vec)

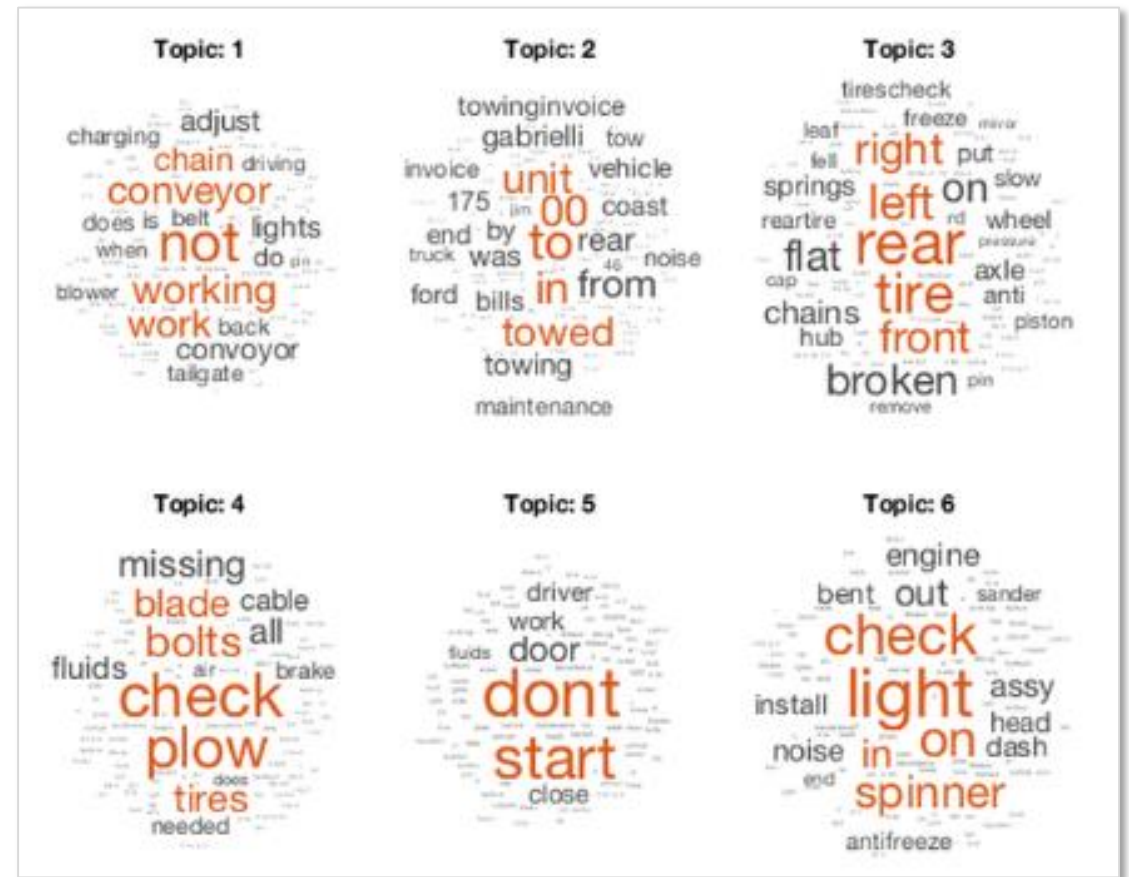

Predictive Maintenance

 Data

 Sensors

 Model

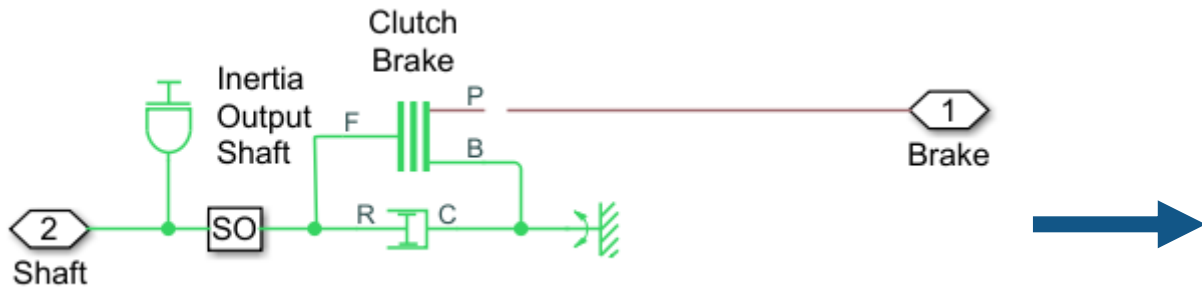

 Output

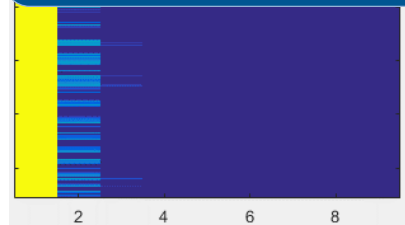

Normal Operation

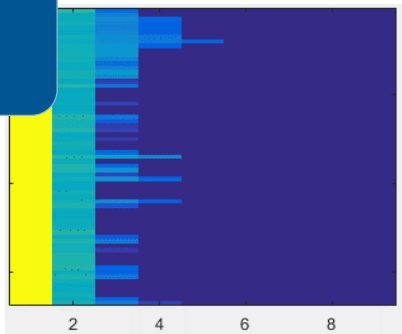

Monitor Closely

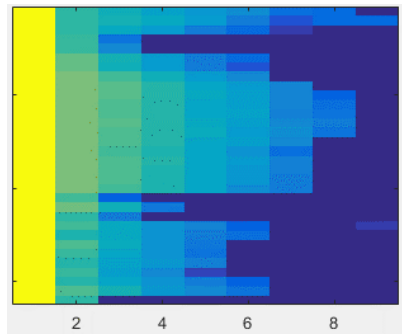

Maintenance Needed

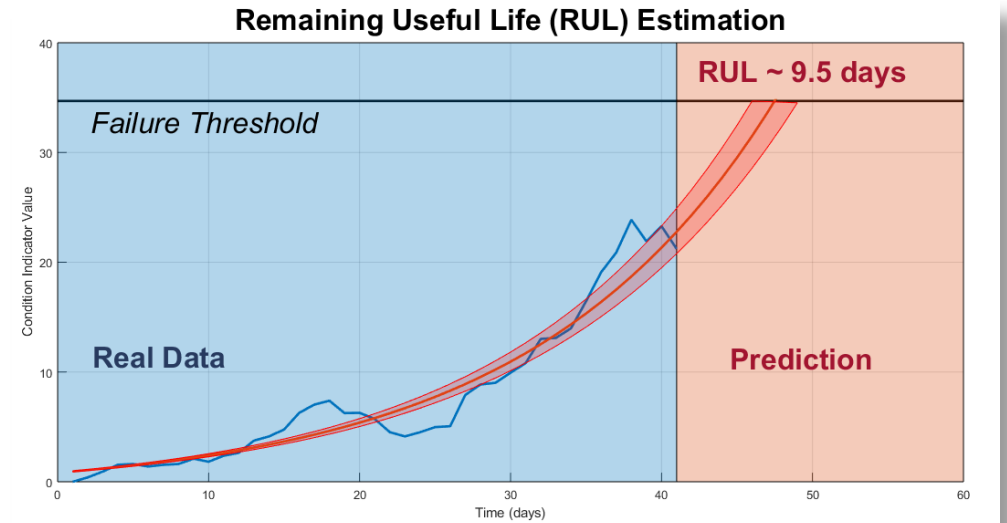

Predictive Maintenance

Design and test condition monitoring and predictive maintenance algorithms

- Import sensor data from local files and cloud storage (*Amazon S3, Windows Azure Blob Storage, and Hadoop HDFS*)
- Use simulated failure data from Simulink models
- Estimate remaining useful life (RUL)
- Get started with examples (*motors, gearboxes, batteries, and other machines*)

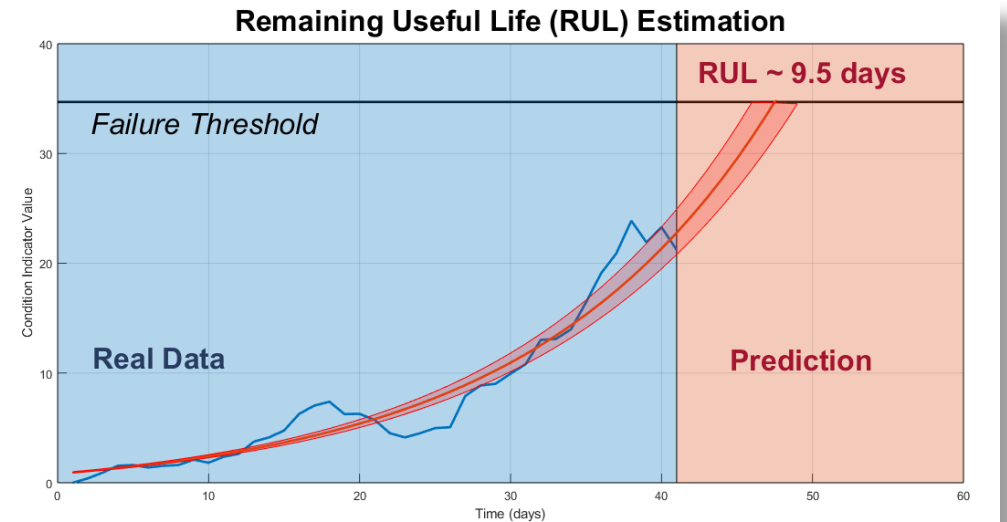

Deep Learning

 Data



 Model

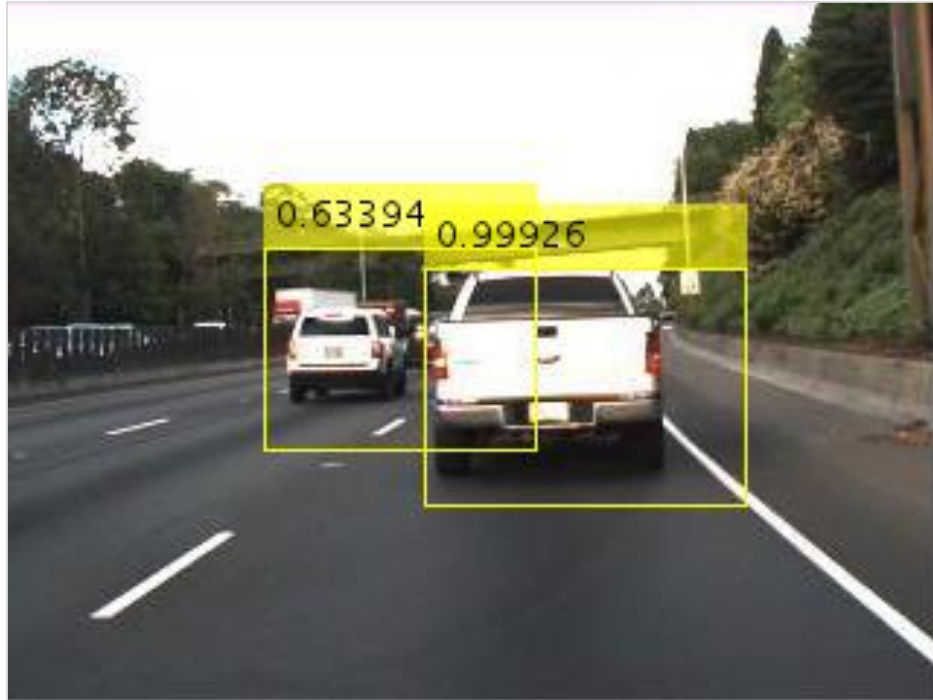

 Output



Deep Learning

Design, build, and visualize convolutional neural networks

- Access the latest models
- Import pretrained models and use transfer learning
- Automate ground-truth labeling using apps
- Design and build your own models
- Use NVIDIA GPUs to train your models
- Automatically generate high-performance CUDA code for embedded deployment

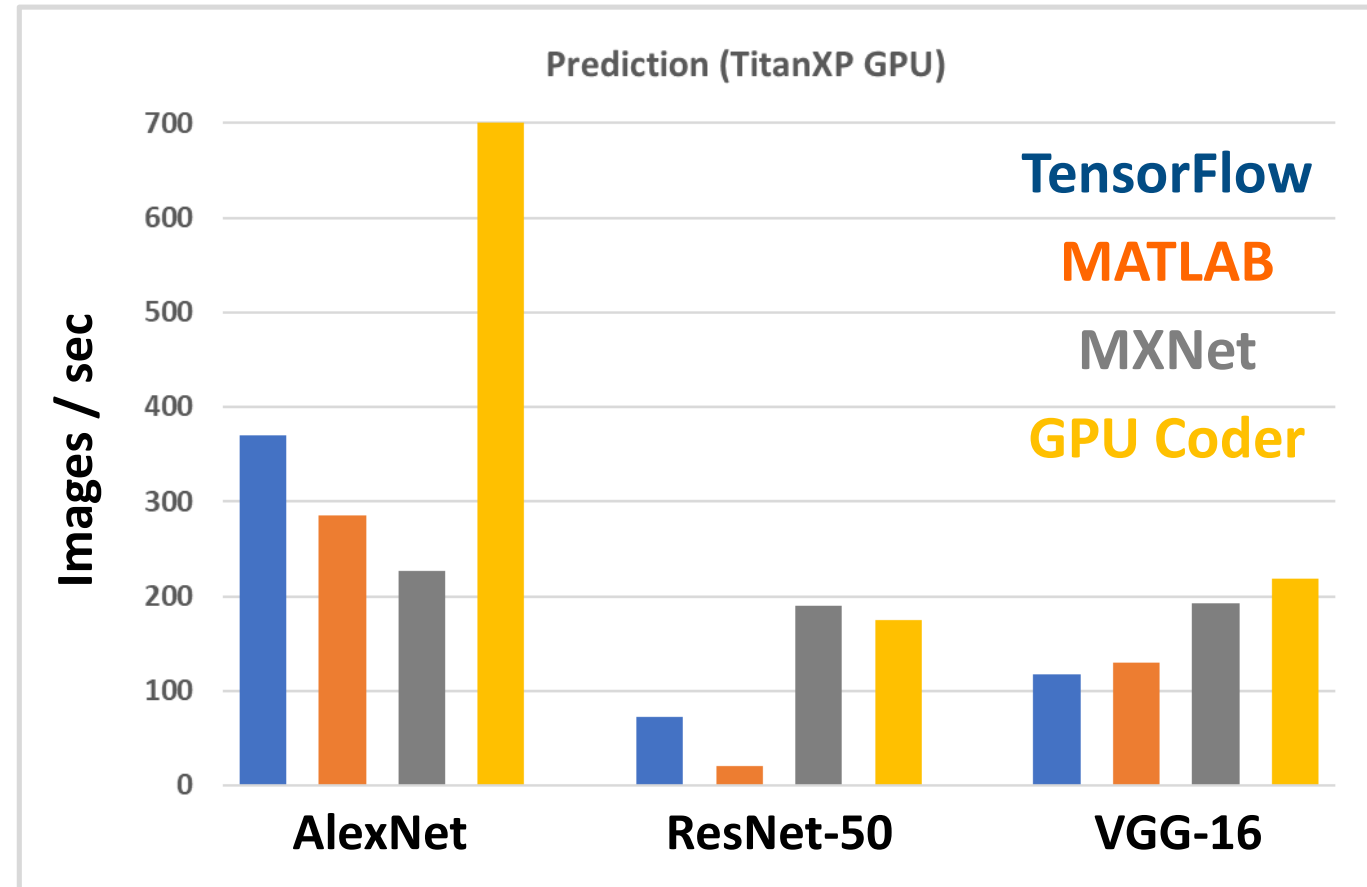

FREE

Learn to Use MATLAB for Deep Learning in 2 Hours

Launch Deep Learning Onramp

The screenshot shows the MATLAB Deep Learning Onramp interface. The top navigation bar includes "My Courses", "Deep Learning Onramp" (51% complete), and the user name "Chal Chitale". The main content area is divided into three sections:

- Task 1:** "Load pretrained network". Instruction: "Use the `alexnet` function to load a pretrained network." Code: `deepnet = alexnet;`
- Task 2:** "Import, view, and classify an image". Instruction: "Import and display the image in `file01.jpg`." Code: `img1 = imread('file01.jpg');` and `imshow(img1)`. Below this, "Task 2: Classify the image in the variable `img1`." Code: `pred1 = classify(deepnet, img1)`. The result shown is `pred1 = categorical seashore`.
- Task 3:** "Classify further images". Instruction: "Classify the images in `file02.jpg` and `file03.jpg`." Code: `img2 = imread('file02.jpg');`

On the left side, there is a "Task 2" summary panel with an "Info" box, a code snippet `pred = classify(net, img);`, and a "Test Suite" section showing a green checkmark for "Is pred1 created correctly?".

What's New in MATLAB and Simulink?

Platform Productivity



- Design Creation
- Analysis
- Simulation, Scaling
- Collaboration

Workflow Depth

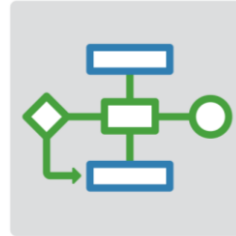

- Deployment
- Code Generation
- Verification and Validation

Application Breadth

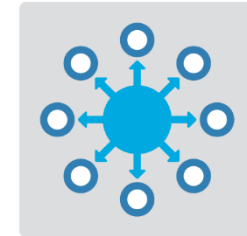

- Autonomous Systems
- Wireless Communications
- Artificial Intelligence (AI)

Upgrade your MATLAB Code and Simulink Models

Web Browser - (3 Errors) Code Compatibility Report

(3 Errors) Code Compatibility Report

Code Compatibility Report [Top](#) [3 Errors](#) [1 Warning](#) [304 Checks](#) [2 Files](#)

Analysis Date: 05-Sep-2017 14:32:08

MATLAB Version: R2017b

Incompatibility and Syntax Errors

Row	Filename	Line	Description
1	classifyBloodPressure.m	18	TREEFIT has been removed
2	classifyBloodPressure.m	21	TREEDISP has been removed. Use TREEVIEW methods instead.
3	classifyBloodPressure.m	24	TREEVAL has been removed. Use TREEPREDICT methods instead.

Warnings and Other Recommendations

Row	Filename	Line	Description
1	classifyBloodPressure.m	Z	RAND or RANDN with true random number generation is not recommended. Use RANDI or RANDJ.

Upgrade Advisor - sf_climate_control

File Edit Run Settings Help

Find:

Upgrade Project Report

100% Passed

	Models	Libraries	MATLAB Code
Passed	7	1	8
Need attention	-	-	-

Show:

Filename	Check Name	Result
AnalogControl.mdl	Check model settings for migration to simplified initialization mode	Passed
analyzeModelFiles.m	Check that the model is saved in SLX format	Passed with fixes
billOfMaterials.m	Check usage of function-call connections	Need attention
checkCodeProblems.m	Check and set embedded target model to use ert.tlc system target file	Passed
DigitalControl.slx	Check and update masked blocks in library to use promoted parameters	Passed
f14_airframe.slx	Check and update mask image display commands with unnecessary imread() function calls	Passed
f14_airframe_test.m	Check and update mask to affirm icon drawing commands dependency on mask workspace	Passed
find_top_models.m	Check and update model to use toolchain approach to build generated code	Passed
LinearActuator.slx		
NonLinearActuator.mdl		
rebuild_s_functions.m		
runUnitTest.m		
slproject_f14.slx		
upgrade_project.m		
vertical_channel.slx		
wind_gust_lib.slx		

Checks run on 02/01/2018 10:44

Identify Variant Model blocks and convert those to Variants

Analysis

Upgrade Variant Model blocks to Variant Subsystems contain offers enhanced capabilities while maintaining equivalent functionality. Variant models will be removed in a future release.

Result: ✔ Passed

Identify Variant Model blocks at model level.

Passed

No Variant Model blocks found.

MATLAB EXPO 2018

