

MATLAB EXPO 2018

Mantenimiento Predictivo

Del Desarrollo al Despliegue de IoT

Lucas García



What is Predictive Maintenance?

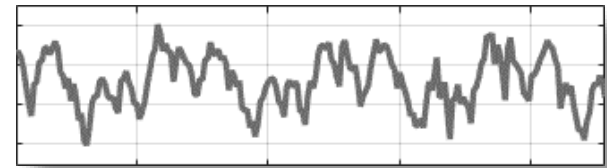
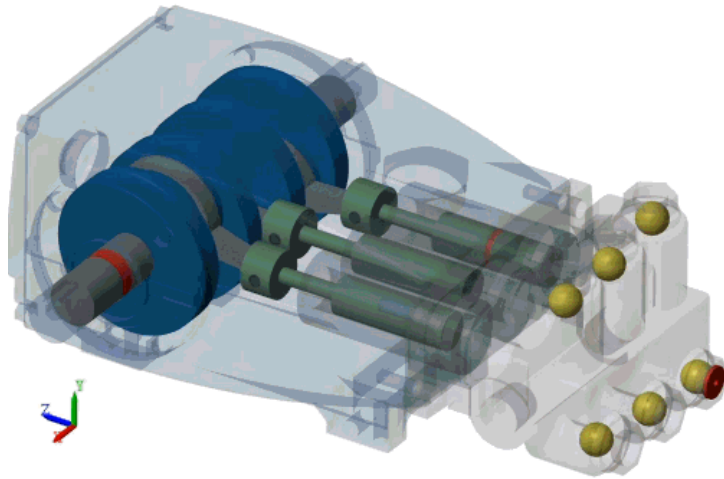



English Spanish French Pump - detected ▼



English Russian Greek ▼

Translate

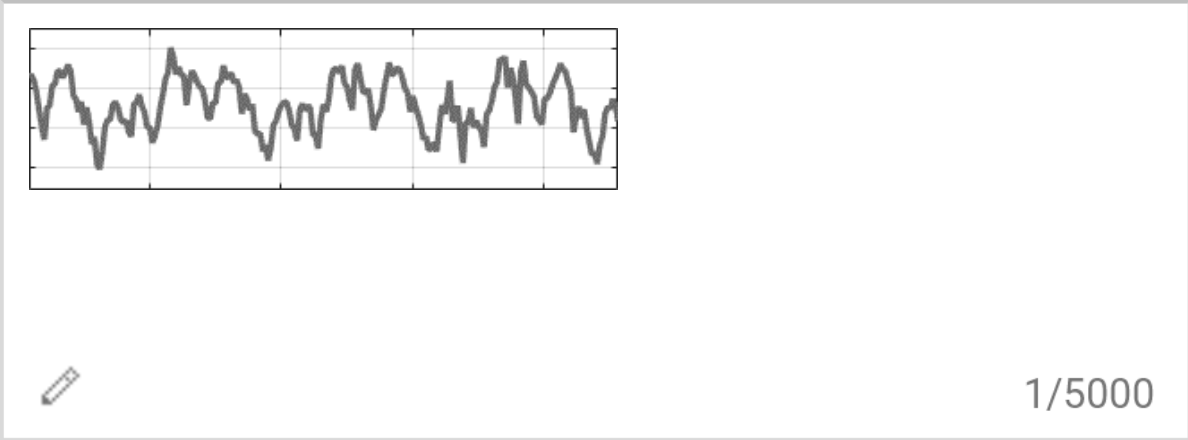

I need help.



English Spanish French Pump - detected ▼



English Russian Greek ▼

Translate

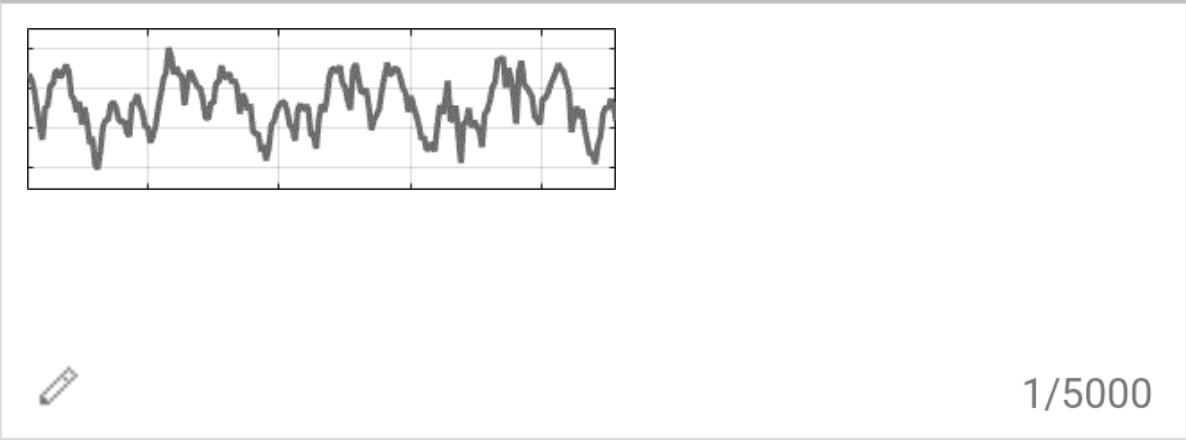

I need help. One of my cylinders is blocked. I will shut down your line in 15 hours

What do you expect from predictive maintenance?

- Maintenance cares about day-to-day operations
 - Reduced downtime
- Operations & IT look at the bigger picture
 - Improved operating efficiency
- Engineering groups get product feedback
 - Better customer experience
- Upper management wants to drive growth
 - New revenue streams

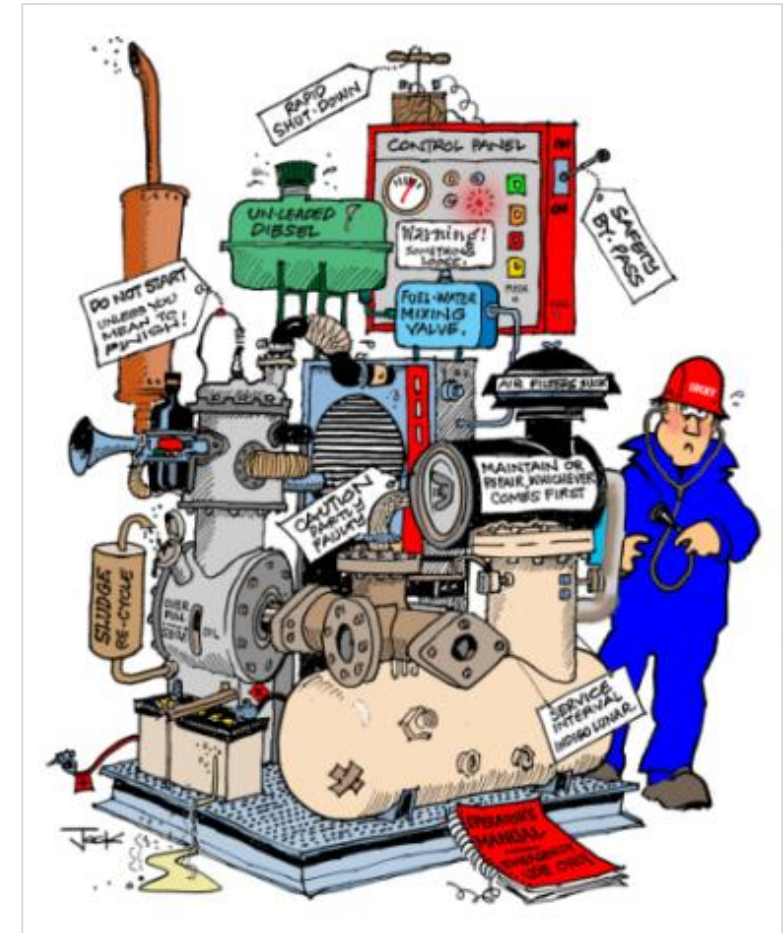

Source: Tensor Systems



<https://es.mathworks.com/videos/mondi-gronau-develops-a-predictive-maintenance-and-process-monit-1481048845257.html>

Industrial Internet of Things

Google search results for "iiot". Navigation tabs: All, News, **Images**, Videos, Books, More. Settings, Tools. View saved, SafeSearch.

- production
- industrial iot
- iiot industrial**
- things iiot
- industrial internet



INDUSTRIAL INTERNET OF THINGS



Industrial IoT



SMART FACTORY

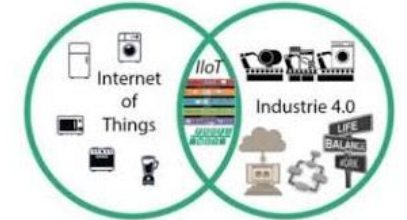
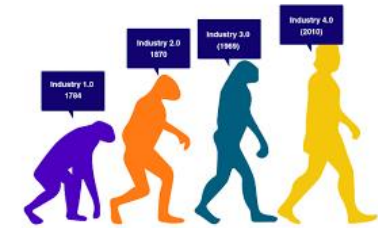

INDUSTRIAL INTERNET OF THINGS



Connected Intelligent Factories Offer New Value Chain Models

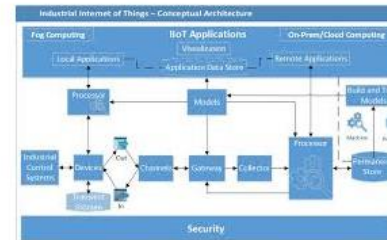
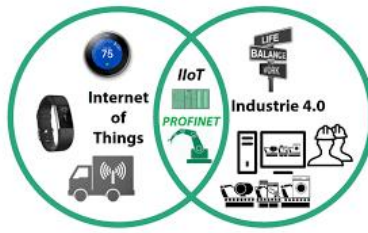

Industrial IoT



Industrial Internet of Things

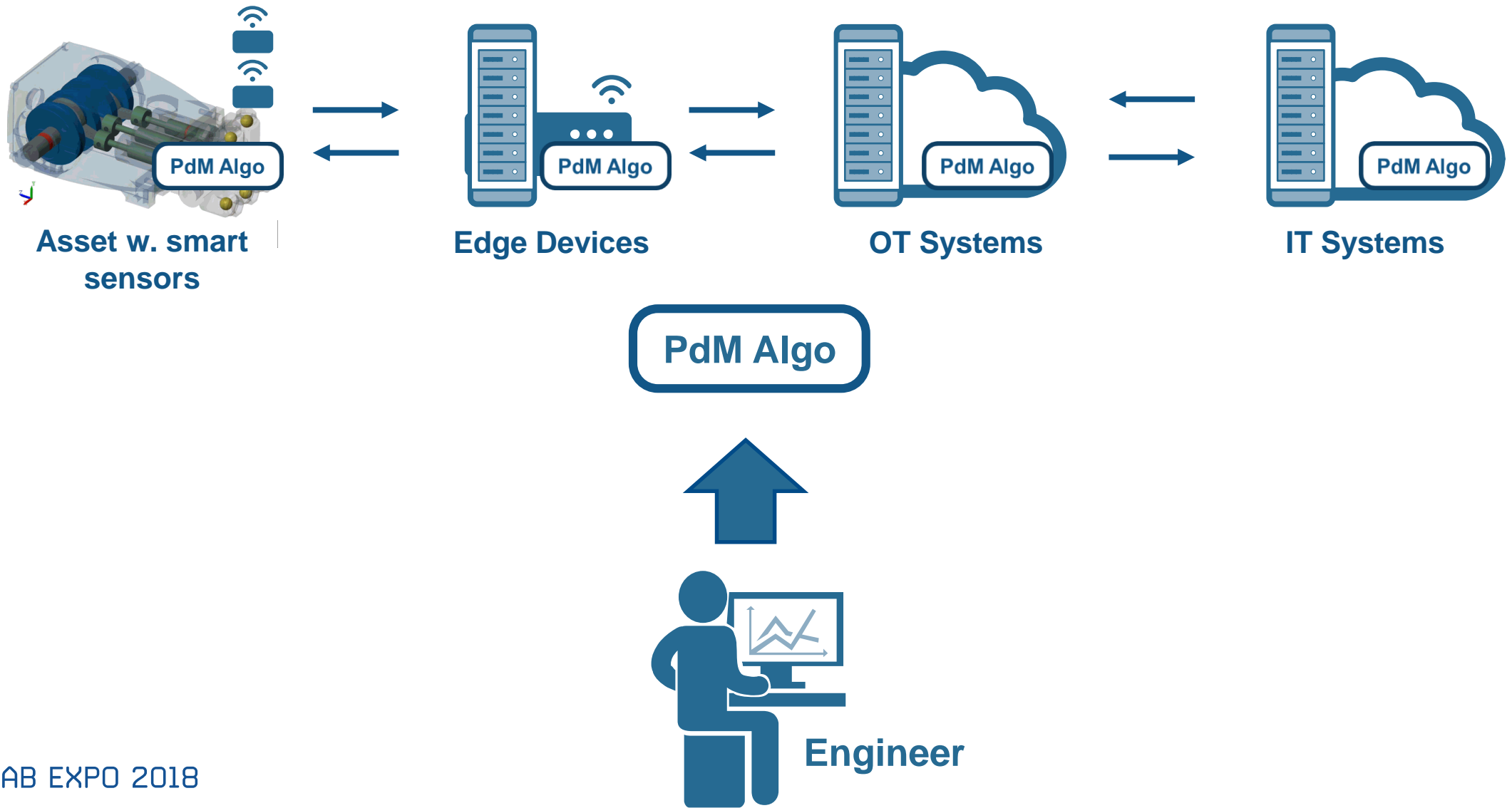

Why MATLAB & Simulink for Predictive Maintenance

- Get started quickly
- Reduce the amount of data you need to store and transmit
- Deliver the results of your analytics based on your audience
- Create training data for your algorithm in the absence of real failure data

Challenges: How much data are you collecting?

- 1 day ~ 1.3 GB
- 20 sensors/pump ~26 GB/day
- 3 pumps ~ 78 GB/day
- Satellite transmission
 - Speeds approx. 128-150 kbps,
 - Cost \$1,000/ 10GB of data
- Needle in a haystack problem

Pump flow sensor 1 sec ~ 1000 samples ~16kB

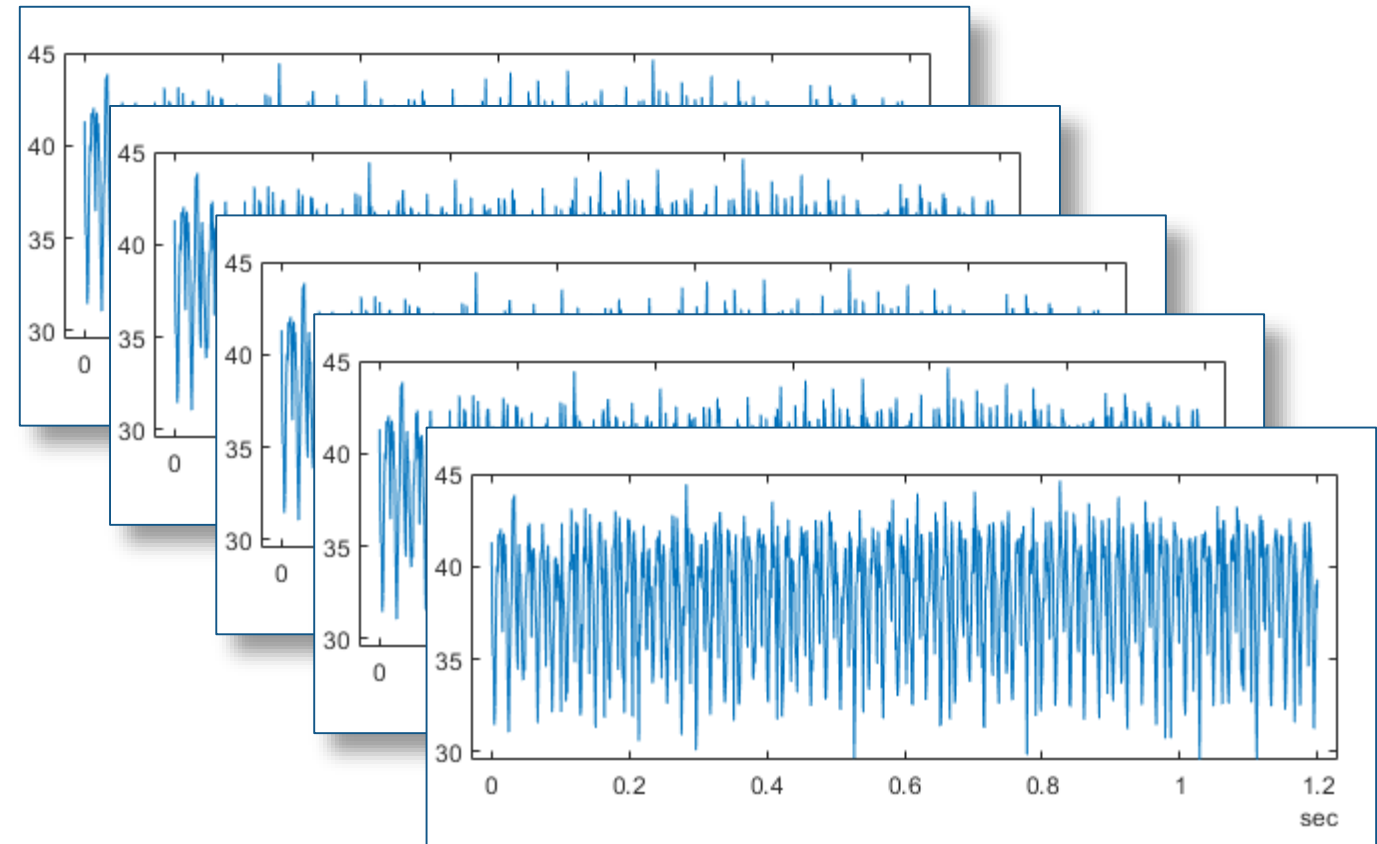

Solution: Feature extraction at the Edge

- How do you extract features?
- Which features should you extract?
- How do I deal with streaming data?

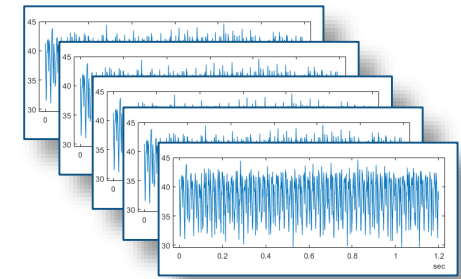

Edge Devices



qMean	qVar	qSkewness	qKurtosis
38.4945	9.2306	-0.5728	2.4662
qPeak2P...	qCrest	qRMS	qMAD
15.2351	1.1553	38.6141	2.5562

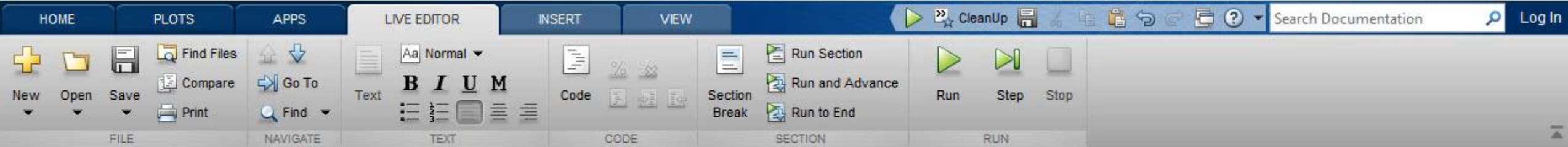

C:\Users\abaru\Desktop\Expo 2018\FinalDemo\Demo_Files\Data_Reduction

Current Folder: Live Editor - C:\Users\abaru\Desktop\Expo 2018\FinalDemo\Demo_Files\Data_Reduction\Expo_Data_Preprocessing_CodeGen.mlx

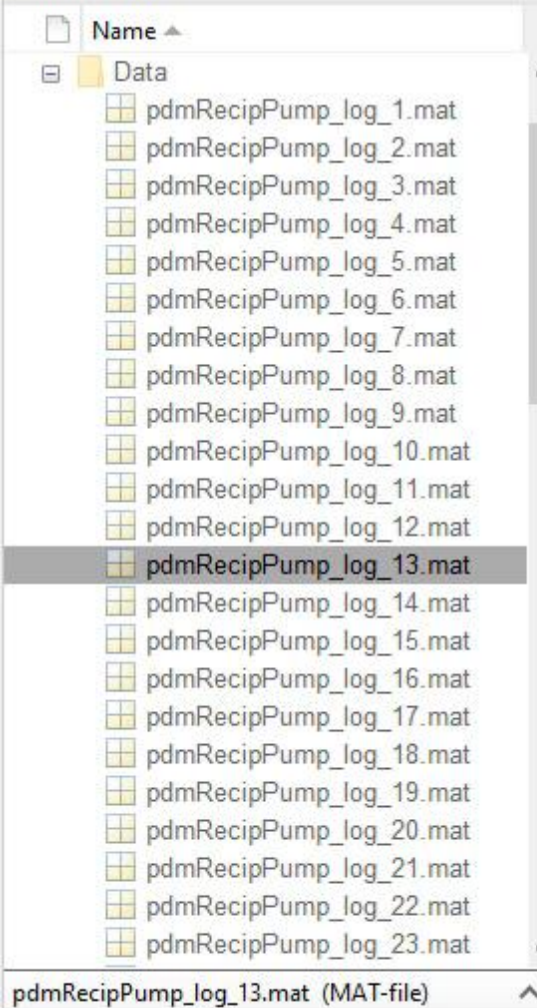

Expo_Data_Preprocessing_CodeGen.mlx x featureExtractionBuffer.m x +

Algorithm Development for Feature Extraction at the Edge

Processing and Extracting Features from the Simulation Results

The model is configured to log the pump output pressure, output flow, motor speed and motor current.

```
1 ens = simulationEnsembleDatastore('.\Data');
2 ens.SelectedVariables = ["qOut_meas", "SimulationInput"];
3 reset(ens)
4 data = read(ens);
5 [flow,time_unit] = preprocess(data);
6 figure;
7 plot(flow.Time,flow.Data);

8 % Decide which features to extract
9
10 ens.DataVariables = [ens.DataVariables; ...
11     "qMean"; "qVar"; "qSkewness"; "qKurtosis"; ...
12     "qPeak2Peak"; "qCrest"; "qRMS"; "qMAD"; "qCSRange"];
13 ens.ConditionVariables = ["Time_Unit"];
14
15 feat = extractCI(flow);
16 dataToWrite = [time_unit, feat];
17 writeToLastMemberRead(ens,dataToWrite{:})
```

Solution: Feature extraction at the Edge

- How do you extract features?
 - Signal processing methods
 - Statistics & model-based methods

- Which features should you extract?
 - Depends on the data available
 - Depends on the hardware available

- How do I deal with streaming data?
 - Determine buffer size
 - Extract features over a moving buffer window

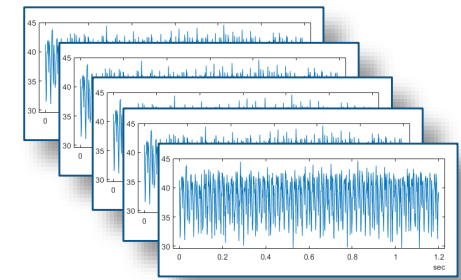

Edge Devices



qMean	qVar	qSkewness	qKurtosis
38.4945	9.2306	-0.5728	2.4662
qPeak2P...	qCrest	qRMS	qMAD
15.2351	1.1553	38.6141	2.5562

Challenges: What do your end users expect?

- Maintenance needs simple, quick information
 - Hand held devices, Alarms



Dashboards & Hand held Devices

Challenges: What do your end users expect?

- Maintenance needs simple, quick information
 - Hand held devices, Alarms

- Operations needs a birds-eye view
 - Integration with IT & OT systems



Data Sources



Streaming Data



Analytics Platforms

Challenges: What do your end users expect?

- Maintenance needs simple, quick information
 - Hand held devices, Alarms
- Operations needs a birds-eye view
 - Integration with IT & OT systems
- Customers expect easy to digest information
 - Automated reports

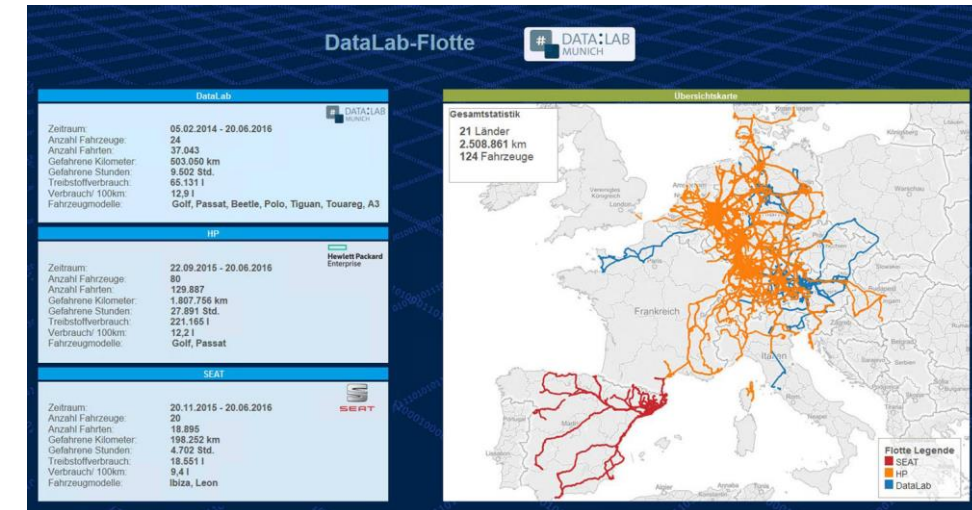

Fleet & Inventory Analysis

Solution: Flexible deployment of algorithms

- Can I reuse my algorithm code for deployment?
- How do I update my predictive model?
- How do I integrate with my IT/OT systems?

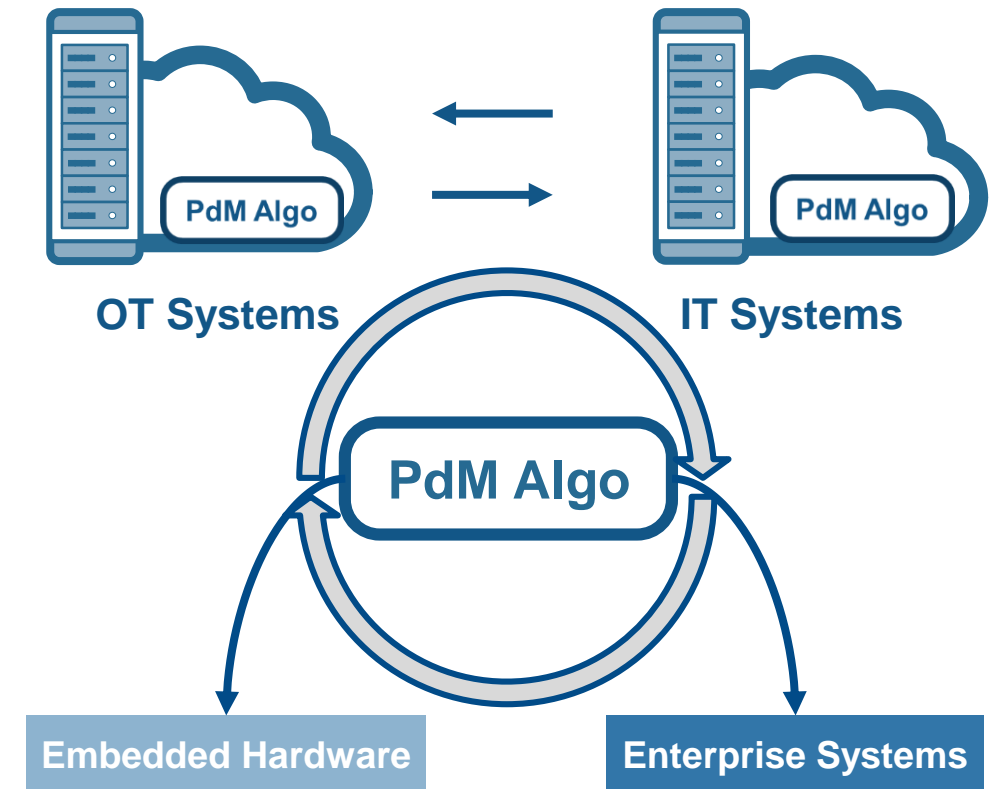

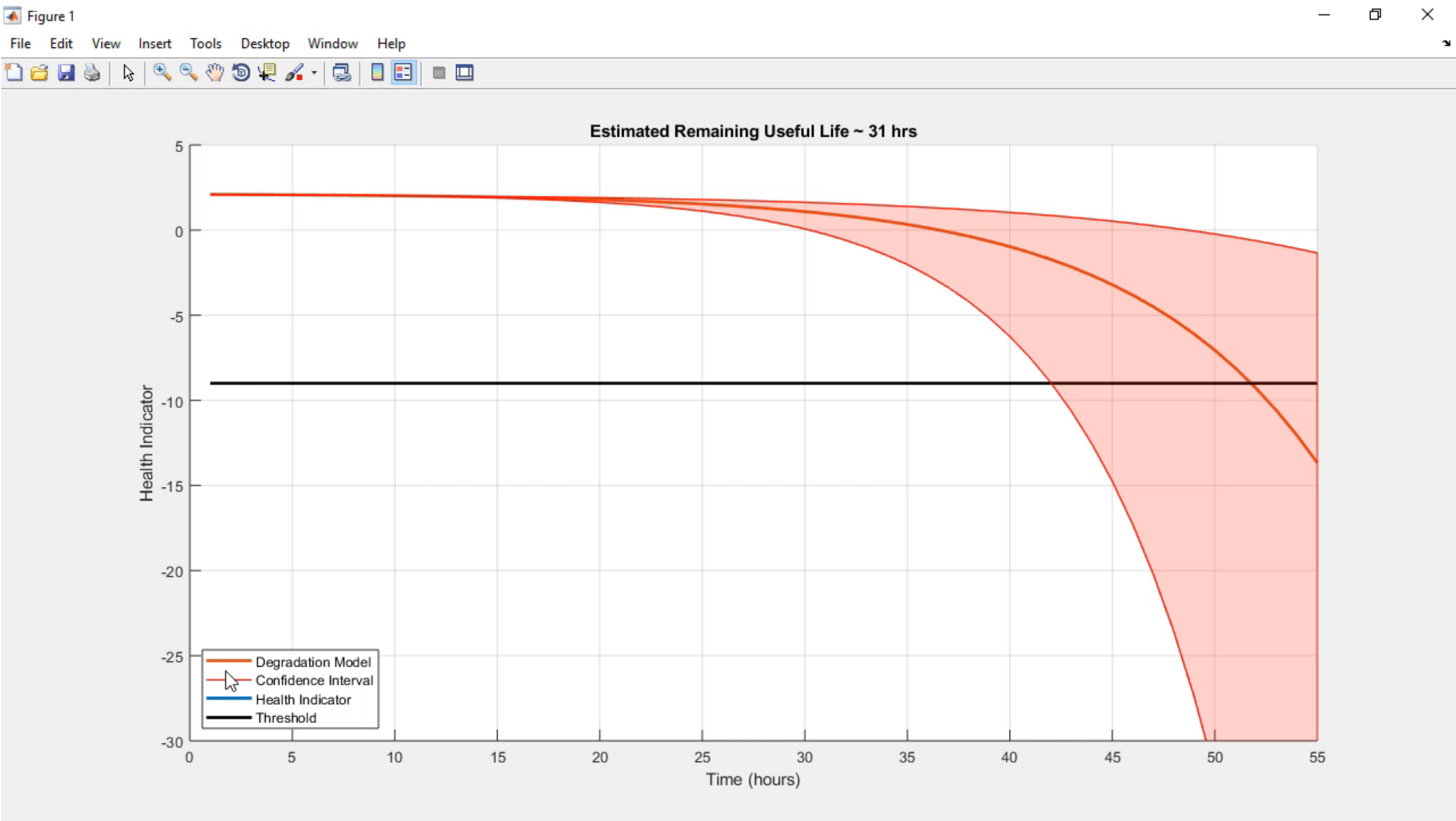

Solution: Flexible deployment of algorithms

- Can I reuse my algorithm code for deployment?
 - Code generation at the Edge
 - Libraries & executables for IT/OT systems
- How do I update my predictive model?
- How do I integrate with my IT/OT systems?

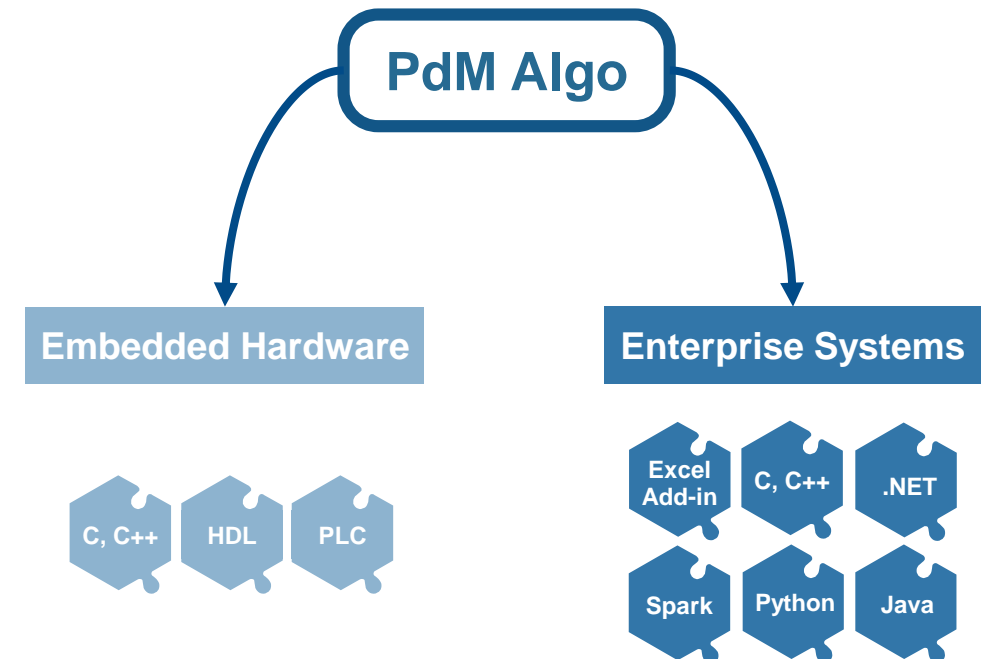

Solution: Flexible deployment of algorithms

- Can I reuse my algorithm code for deployment?
 - Code generation at the Edge
 - Libraries & executables for IT/OT systems
- How do I update my predictive model?
 - Retrain degradation models for RUL estimation
 - Retrain classification models for fault isolation
- How do I integrate with my IT/OT systems?



Solution: Flexible deployment of algorithms

- Can I reuse my algorithm code for deployment?
 - Code generation at the Edge
 - Libraries & executables for IT/OT systems
- How do I update my predictive model?
 - Retrain degradation models for RUL estimation
 - Retrain classification models for fault isolation
- How do I integrate with my IT/OT systems?
 - Connect to data sources & scale computations
 - Connect to dashboards & analytics platforms

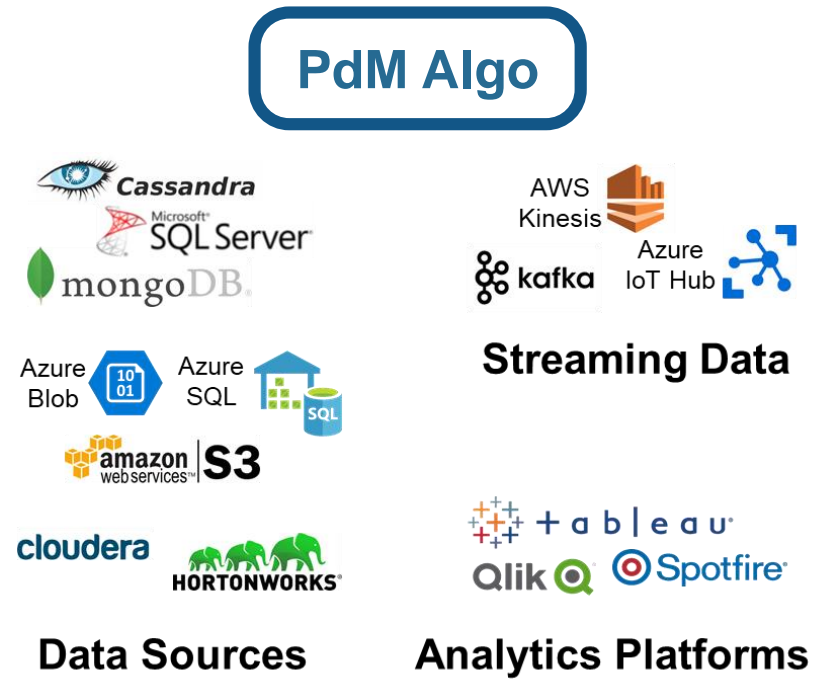
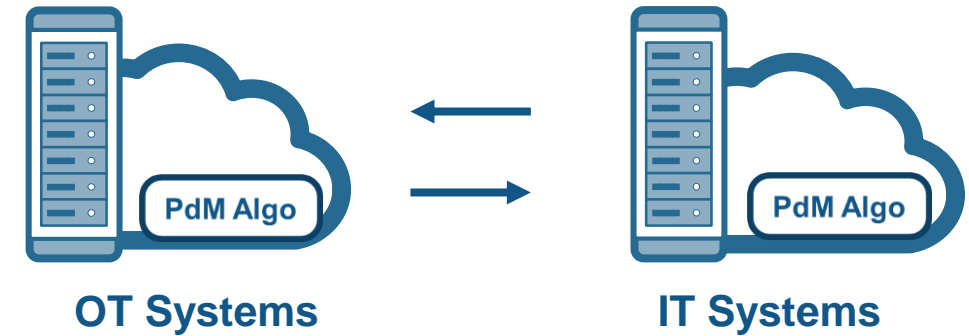

Challenges: What if you don't have the data you need?

- Lack of labelled failure data
- Multiple failure modes and failure combinations possible
- Different machines can show different behavior for the same failure

Solution: Generating failure data from Simulink models

- How do I model failure modes?
- How do I customize a generic model to a specific machine?
- How do I know if the data is accurate?

File Explorer Simulation View Tools Help

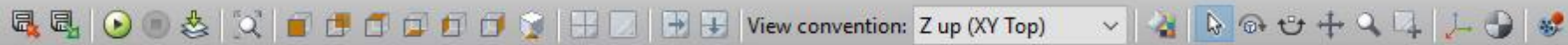

View convention: Z up (XY Top)

MENU AND TOOLBARS

Mechanics Explorers - Mechanics Explorer-sm_pump_triplex

Mechanics Explorer-sm_pump_triplex

- sm_pump_triplex
 - Driver
 - Pump
 - Connection Frames

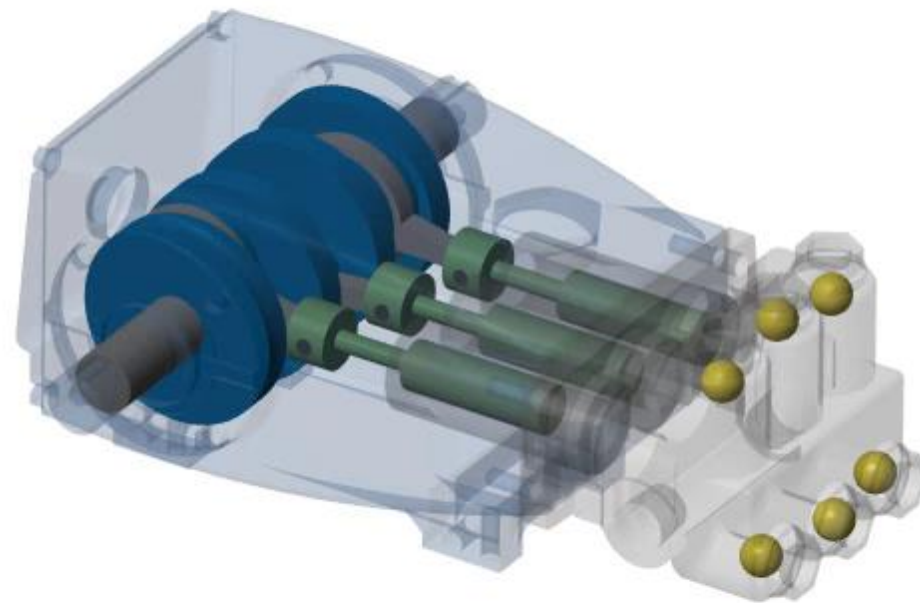

T = [0,1.5]

1/8X

Time 1.5

Command Window

fx >>

Solution: Generating failure data from Simulink models

- How do I model failure modes?
 - Work with domain experts and the data available
 - Vary model parameters or components
- How do I customize a generic model to a specific machine?
 - Fine tune models based on real data
 - Validate performance of tuned model
- How do I know if the data is accurate?

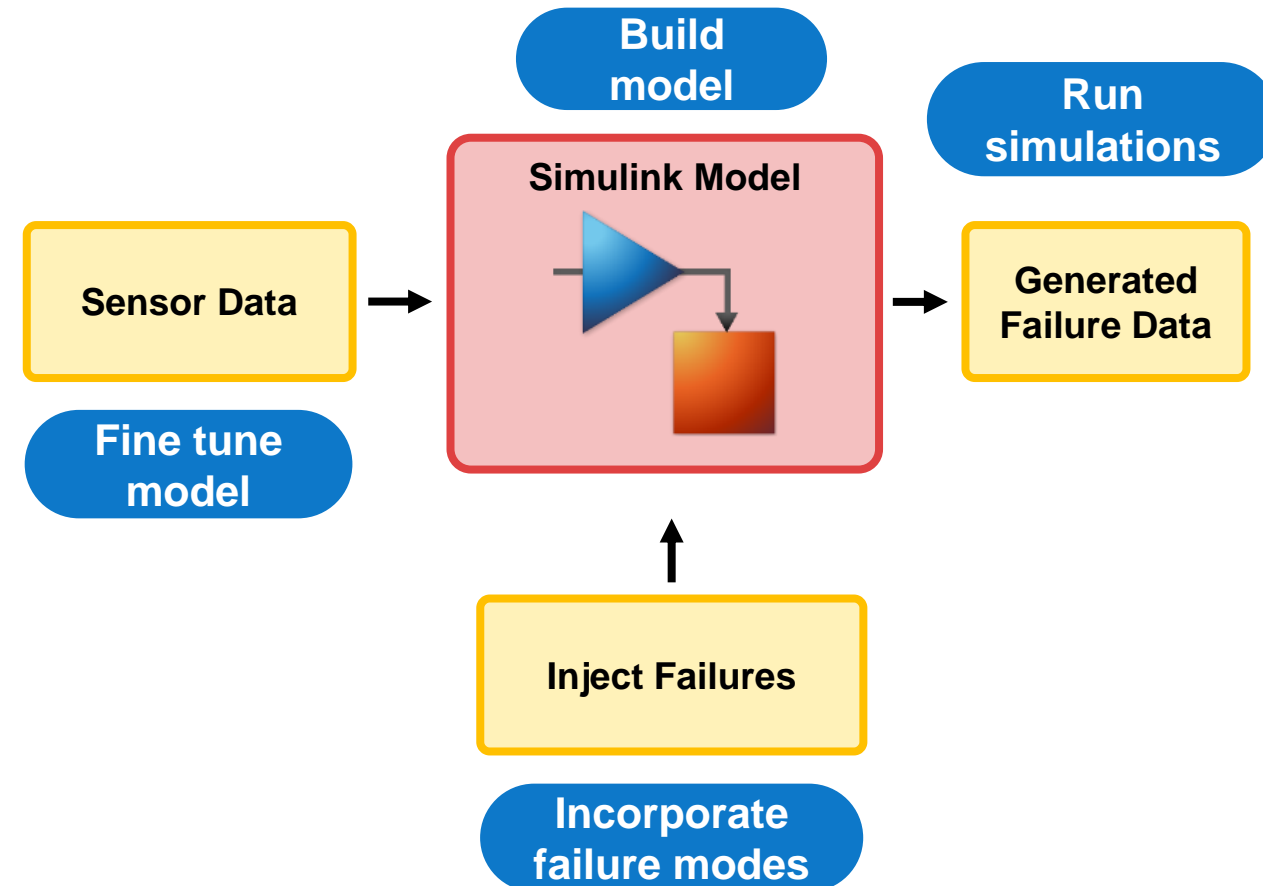

Solution: Generating failure data from Simulink models

- How do I know if the data is accurate?
 - Work
 - available
 - Vary
- How do I know if the data is accurate?
 - Fine
 - Valid
- How do I know if the data is accurate?

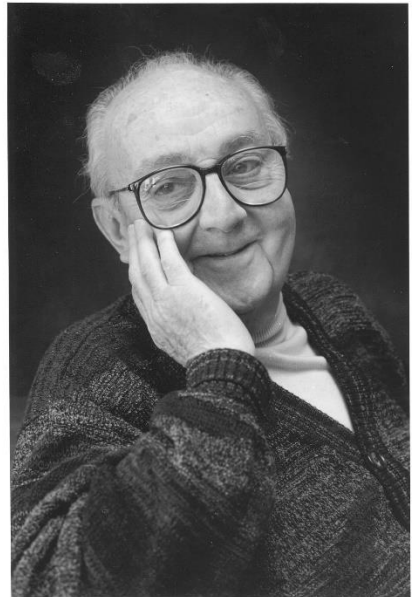

“Essentially, all models are wrong,
but some are useful”

George E.P. Box

Inject Failures

3. Incorporate
failure modes

4. Run
simulations

Generated
Failure Data

Why MATLAB & Simulink for Predictive Maintenance

- Get started quickly
- Reduce the amount of data you need to store and transmit
- Deliver the results of your analytics based on your audience
- Create training data for your algorithm in the absence of real failure data