



# MATLAB EXPO 2017

NXP Motor Control Toolbox

For MATLAB/Simulink Modeling and Code Generation

Mike Cao , NXP Automotive Senior FAE



## Introduction: Model Based Design (MBD)

- Model Based Design is becoming more common during the normal course of software development to explain and implement the desired behavior of a system. The challenge is to take advantage of this approach and get an executable that can be simulated and implemented directly from the model to help you get the product to market in less time and with higher quality. This is especially true for electric motor controls development in this age of hybrid/electric vehicles and the industrial motor control application space.
- Many companies model their controller algorithm and the target motor or plant so they can use a simulation environment to accelerate their algorithm development.
- The final stage of this type of development is the integration of the control algorithm software with target MCU hardware. This is often done using hand code or a mix of hand code and model-generated code. NXP's Model Based Design Toolbox allows this stage of the development to generate 100% of the code from the model.

# Introduction: Reduce Development Time With MBD Toolbox

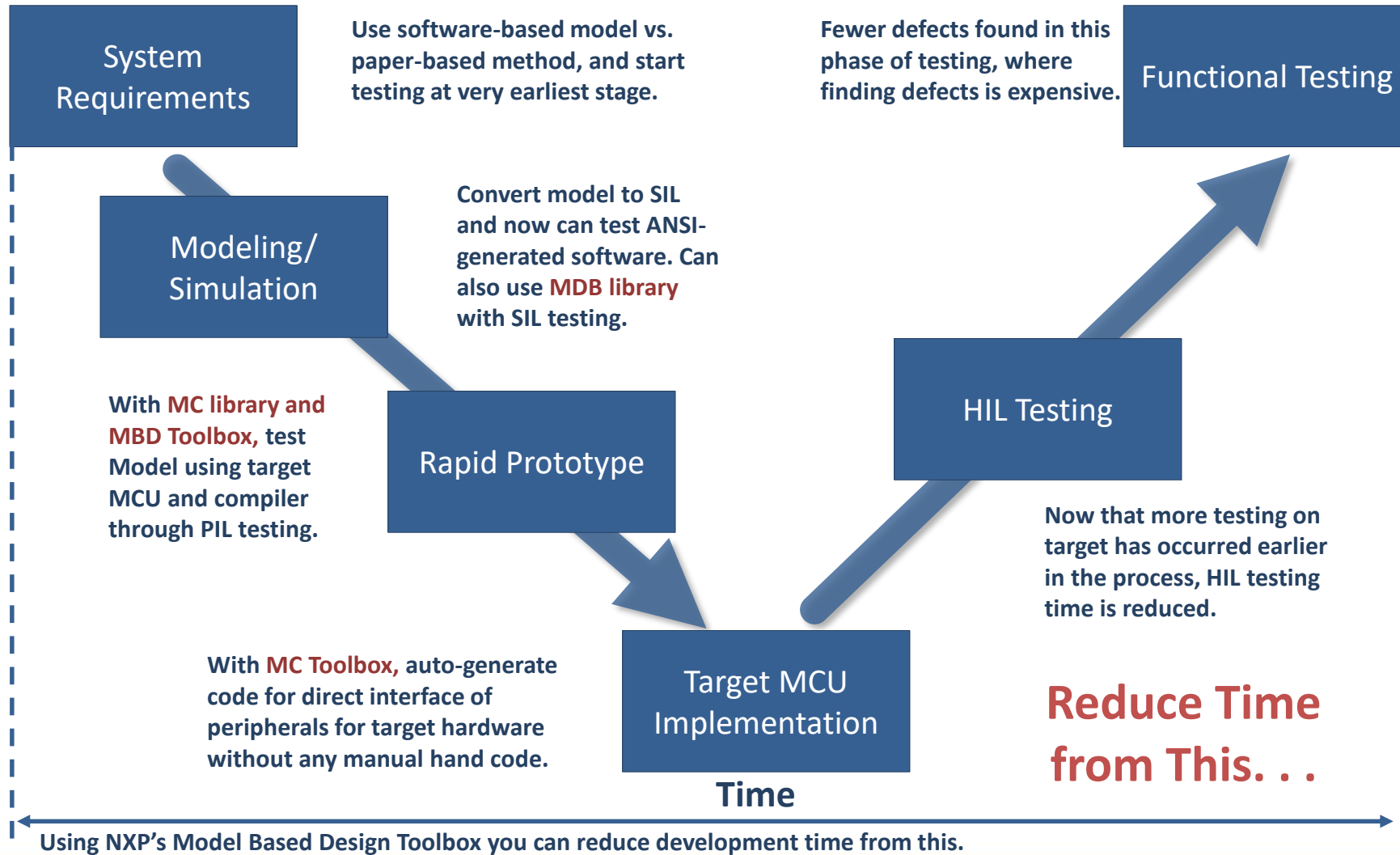

# Introduction: Reduce Development Time With MBD Toolbox

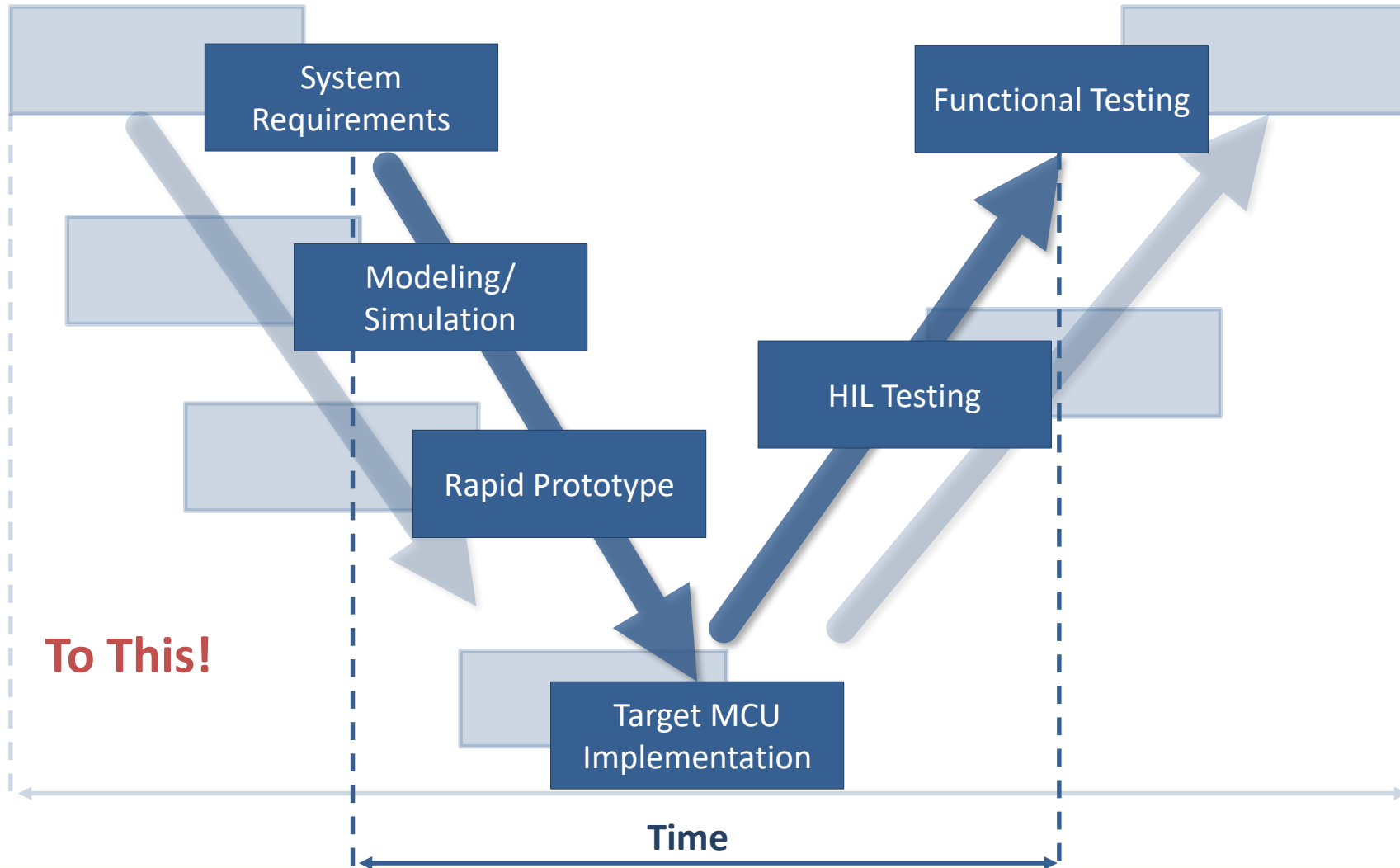

## Introduction: What Do We Do?

- One of the Automotive Tools Enablement & Engineering group's objectives is to develop software enablement tools to assist our customers with rapid prototyping and accelerate algorithm development on their target NXP MCU
- This includes software tools that automatically generate peripheral initialization code through GUI configuration, to generating peripheral driver code from a Model Based Design environment like Simulink™

## Exposure to NXP's hardware/software enablement

NXP DEVKIT-MPC5744P



NXP S32K EVB Kit



Model Based Design Toolbox with Simulink™



**Model-based design  
Driver configuration  
Assignment to pins  
Initialization setup**

MTRCKTSBNZVM128



RAppID Bootloader Utility

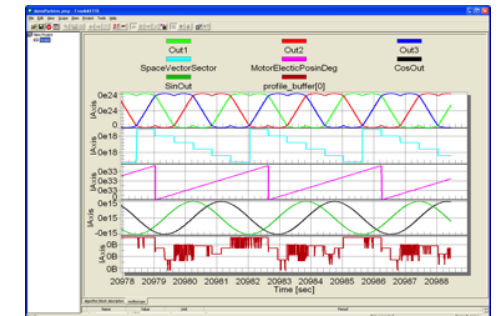
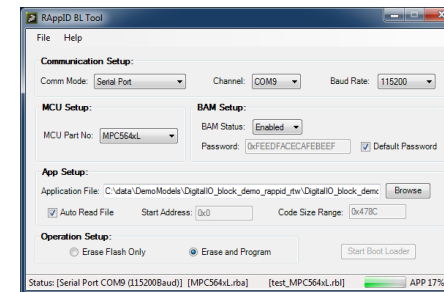

**Signal Visualization  
and Data Acquisition Tool**



## Model Based Design Toolbox Overview

- The Model Based Design Toolbox includes an embedded target supporting NXP MCUs and Simulink™ plug-in libraries which provide engineers with an integrated environment and tool chain for configuring and generating the necessary software, including initialization routines, device drivers, and a real-time scheduler to execute algorithms specifically for controlling motors.
- The toolbox also includes an extensive Automotive Math and Motor Control Function Library developed by NXP's renowned Motor Control Center of Excellence. The library provides dozens of blocks optimized for fast execution on NXP MCUs with bit-accurate results compared to Simulink™ simulation using single-precision math.
- The toolbox provides built-in support for Software and Processor-in-the-Loop (SIL and PIL), which enables direct comparison and plotting of numerical results.

### MathWorks products required for MBD Toolbox:

- MATLAB (32-Bit or 64-Bit)
- Simulink
- MATLAB Coder
- Simulink Coder
- Embedded Coder

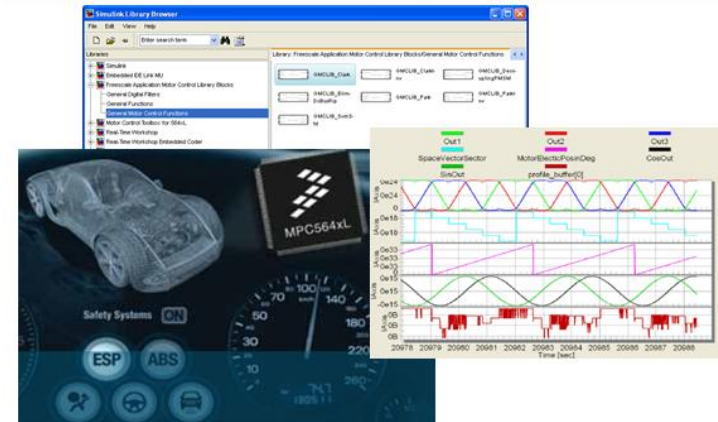

# MBD Toolbox: Toolbox Library Contents

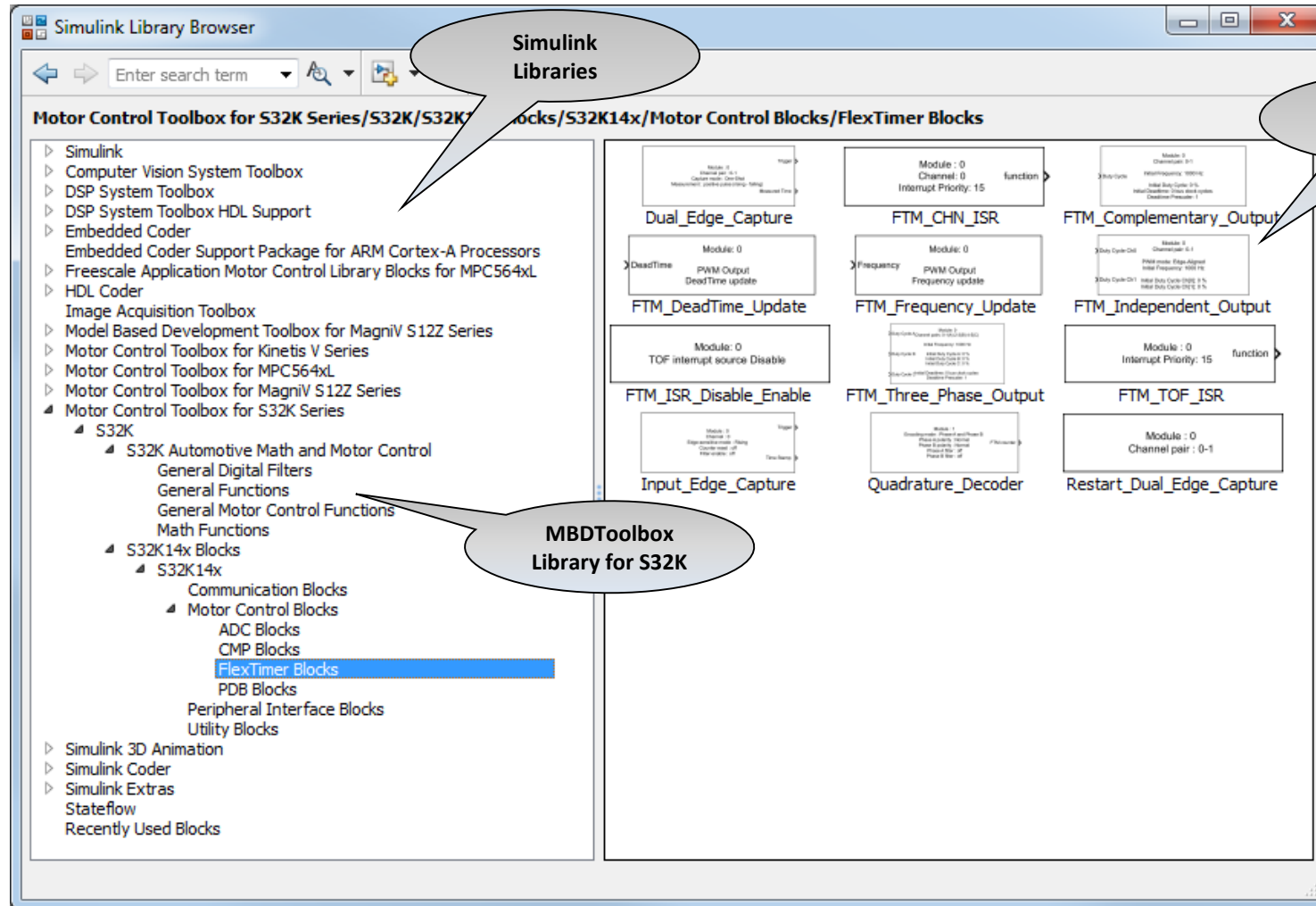

## MBD Toolbox: Toolbox Library Contents

## Peripherals

- General
  - ADC conversion
  - Digital I/O
  - PIT timer
  - ISR
- Communication Interface
  - CAN driver
  - SPI driver
  - I2C
- Motor Control Interface
  - Cross triggering unit
  - PWM
  - eTimer block(s)
  - Sine wave generation
  - ADC Command List
  - GDU (Gate Drive Unit)
  - PTU (Prog Trigger Unit)
  - TIM Hall Sensor Port
  - FTM (Flex Timer Module)
  - PDB (Programmable Delay Block)

## Configuration/Modes

- Compiler Options
  - CodeWarrior
  - Wind River DIAB
  - Green Hills
  - Cosmic
  - IAR
  - GCC
  - RAM/FLASH targets
- Simulation Modes
  - Normal
  - Accelerator
  - Software in the Loop (SIL)
  - Processor in the Loop (PIL)
- MCU Option
  - Multiple packages
  - Multiple Crystal frequencies

## Utility

- FreeMASTER Interface
  - Data acquisition / Calibration
  - Customize GUI
- Profiler Function
  - Exec. time measurement
  - Available in PIL
  - Available in standalone
- Memory Read and Write

## MCUs Supported

- **MPC5643L**
- **MPC567xK**
- **MPC574xP**
- **S12ZVM**
- **S32K**



# MBD Toolbox: Auto Math and Motor Control Library Contents

## Automotive Math and Motor Control Library Set

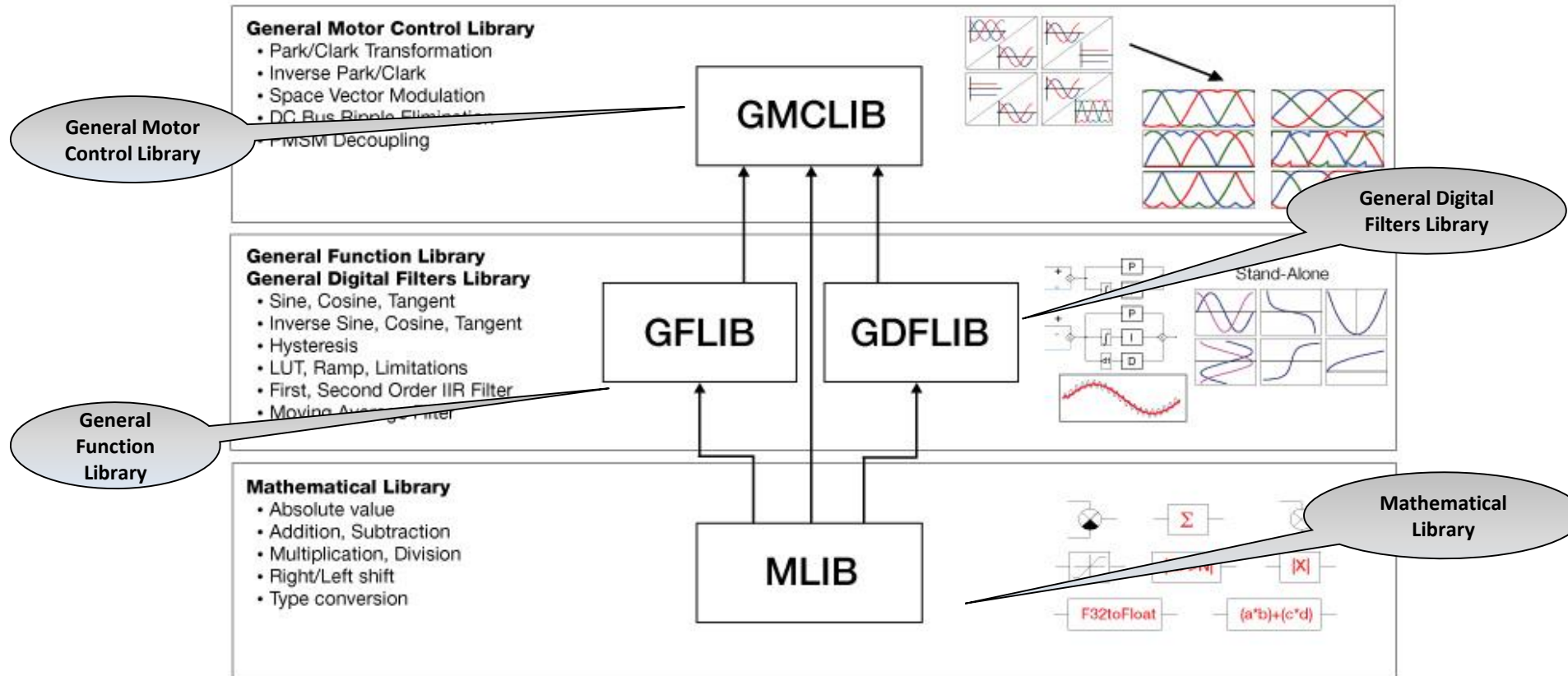

# MBD Toolbox: Auto Math and Motor Control Library Contents

## MLIB

- **Absolute Value, Negative Value**
  - MLIB\_Abs, MLIB\_AbsSat
  - MLIB\_Neg, MLIB\_NegSat
- **Add/Subtract Functions**
  - MLIB\_Add, MLIB\_AddSat
  - MLIB\_Sub, MLIB\_SubSat
- **Multiply/Divide/Add-multiply Functions**
  - MLIB\_Mul, MLIB\_MulSat
  - MLIB\_Div, MLIB\_DivSat
  - MLIB\_Mac, MLIB\_MacSat
  - MLIB\_VMac
- **Shifting**
  - MLIB\_ShL, MLIB\_ShLSat
  - MLIB\_ShR
  - MLIB\_ShBi, MLIB\_ShBiSat
- **Normalisation, Round Functions**
  - MLIB\_Norm, MLIB\_Round
- **Conversion Functions**
  - MLIB\_ConvertPU, MLIB\_Convert

## GFLIB

- **Trigonometric Functions**
  - GFLIB\_Sin, GFLIB\_Cos, GFLIB\_Tan
  - GFLIB\_Asin, GFLIB\_Acos, GFLIB\_Atan, GFLIB\_AtanYX
  - GFLIB\_AtanYXShifted
- **Limitation Functions**
  - GFLIB\_Limit, GFLIB\_VectorLimit
  - GFLIB\_LowerLimit, GFLIB\_UpperLimit
- **PI Controller Functions**
  - GFLIB\_ControllerPIr, GFLIB\_ControllerPIrAW
  - GFLIB\_ControllerPIp, GFLIB\_ControllerPIpAW
- **Interpolation**
  - GFLIB\_Lut1D, GFLIB\_Lut2D
- **Hysteresis Function**
  - GFLIB\_Hyst
- **Signal Integration Function**
  - GFLIB\_IntegratorTR
- **Sign Function**
  - GFLIB\_Sign
- **Signal Ramp Function**
  - GFLIB\_Ramp
- **Square Root Function**
  - GFLIB\_Sqrt

## GDFLIB

- **Finite Impulse Filter**
  - GDFLIB\_FilterFIR
- **Moving Average Filter**
  - GDFLIB\_FilterMA
- **1st Order Infinite Impulse Filter**
  - GDFLIB\_FilterIIR1init
  - GDFLIB\_FilterIIR1
- **2nd Order Infinite Impulse Filter**
  - GDFLIB\_FilterIIR2init
  - GDFLIB\_FilterIIR2

## GMCLIB

- **Clark Transformation**
  - GMCLIB\_Clark
  - GMCLIB\_ClarkInv
- **Park Transformation**
  - GMCLIB\_Park
  - GMCLIB\_ParkInv
- **Duty Cycle Calculation**
  - GMCLIB\_SvmStd
- **Elimination of DC Ripples**
  - GMCLIB\_ElimDcBusRip
- **Decoupling of PMSM Motors**
  - GMCLIB\_DecouplingPMSM

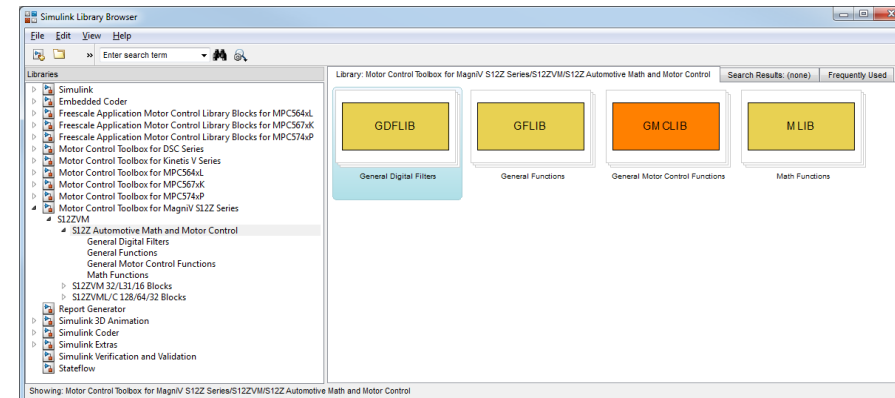

## MBD Toolbox: RAppID Bootloader Utility

The RAppID Bootloader works with the built-in Boot Assist Module (BAM) included in the NXP Qorivva and also supports S12 MagniV, Kinetis, and DSCs family of parts. The Bootloader provides a streamlined method for programming code into FLASH or RAM on either target EVBs or custom boards. Once programming is complete, the application code automatically starts.

### Modes of Operation

The Bootloader has two modes of operation: for use as a stand-alone PC desktop GUI utility, or for integration with different user required tools chains through a command line interface (i.e. Eclipse Plug-in, MATLAB/Simulink, ...)

### MCUs Supported

MPC5534, MPC5601/2D, MPC5602/3/4BC, MPC5605/6/7B, MPC564xB/C, MPC567xF, MPC567xK, MPC564xL, MPC5604/3P, MPC574xP, S12ZVM, S32K, KV10, KV3x, KV4x, KV5x, 56F82xx and 56F84xx.

Graphical User Interface

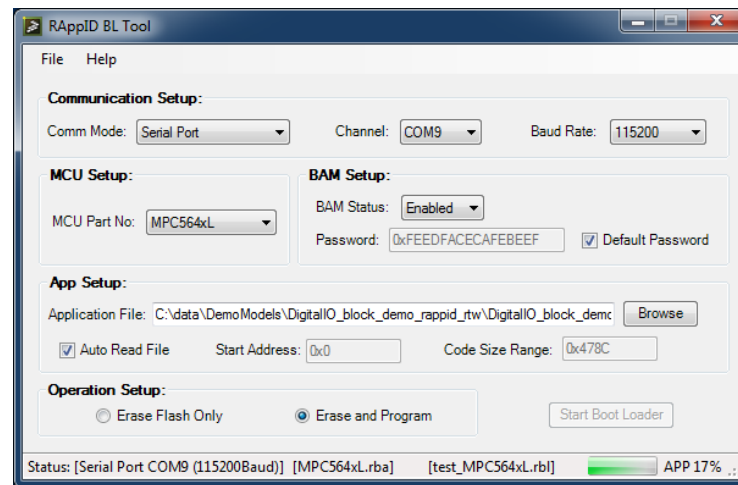

Command

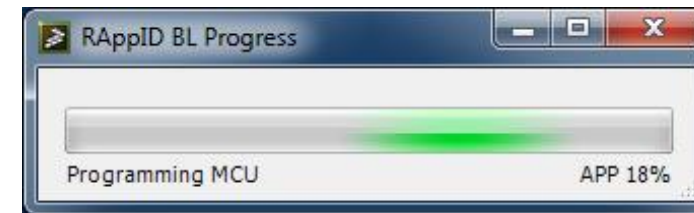

Status given in two stages:  
Bootloader download, then  
application programming

## FreeMASTER — Run Time Debugging Tool

User-friendly tool for real-time debug monitor and data visualization

- Completely non-intrusive monitoring of variables on a running system
- Display multiple variables changing over time on an oscilloscope-like display, or view the data in text form
- Communicates with an on-target driver via USB, BDM, CAN, UART

Establish a Data Trace on Target

- Set up buffer (up to 64 KB), sampling rate and trigger
- Near 10- $\mu$ s resolution

<http://www.nxp.com/freemaster>

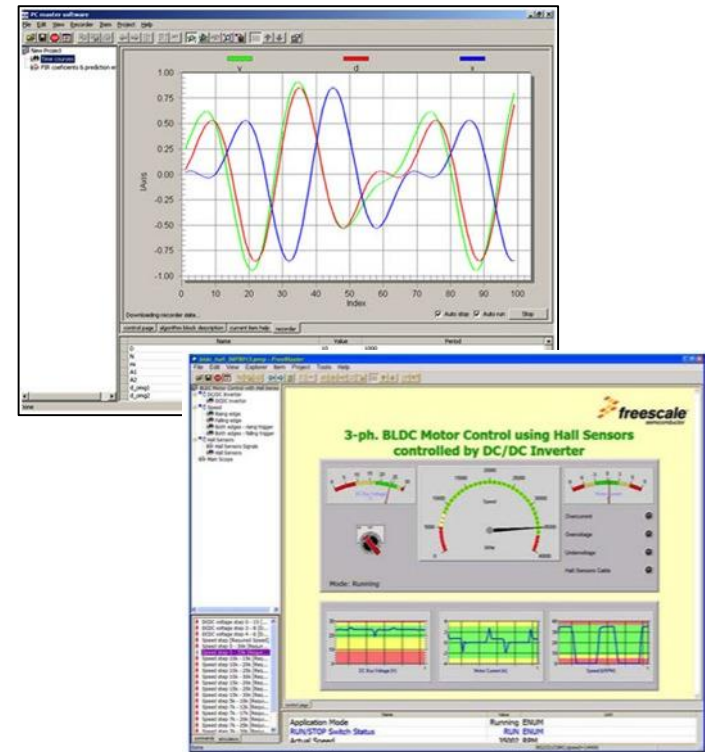

USB  
BDM  
CAN  
UART  
JTAG  
Ethernet



# MBD Toolbox: Summary of Application Support

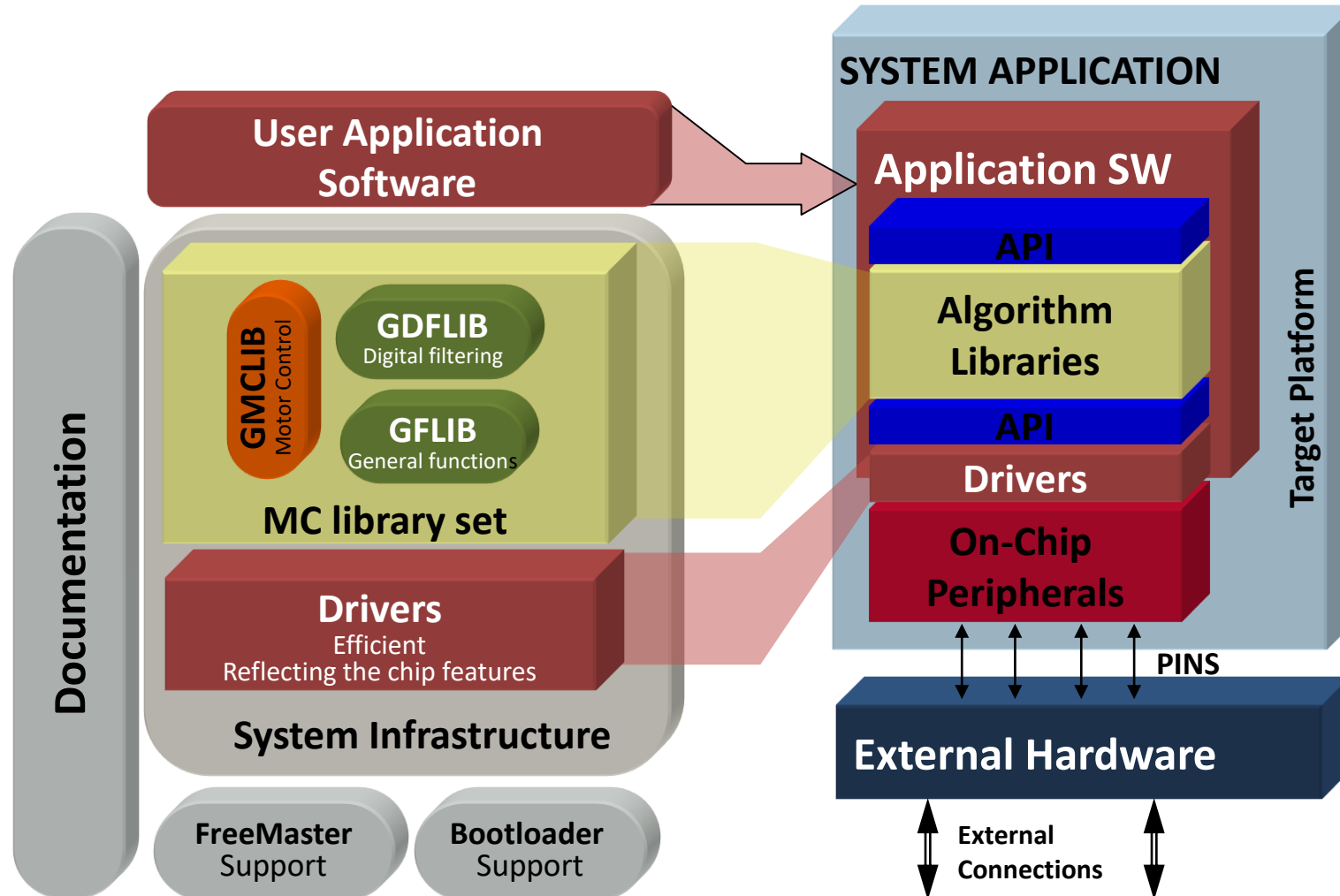



# Model Based Design Steps: Step 1 (Simulation)

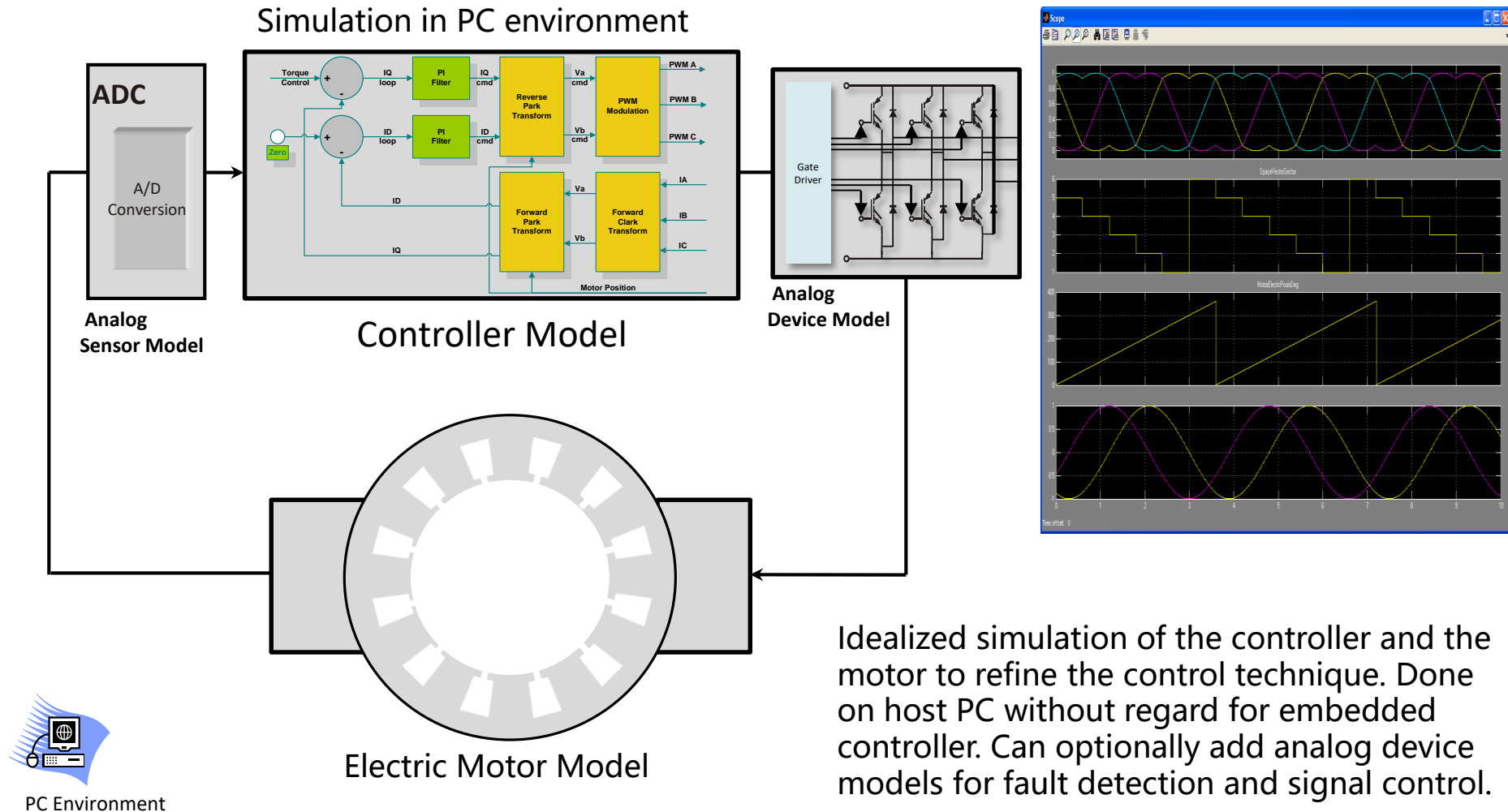

Idealized simulation of the controller and the motor to refine the control technique. Done on host PC without regard for embedded controller. Can optionally add analog device models for fault detection and signal control.



# Model Based Design Steps: Step 2 (SIL)

**(SIL) Generated code executes as atomic unit on PC**

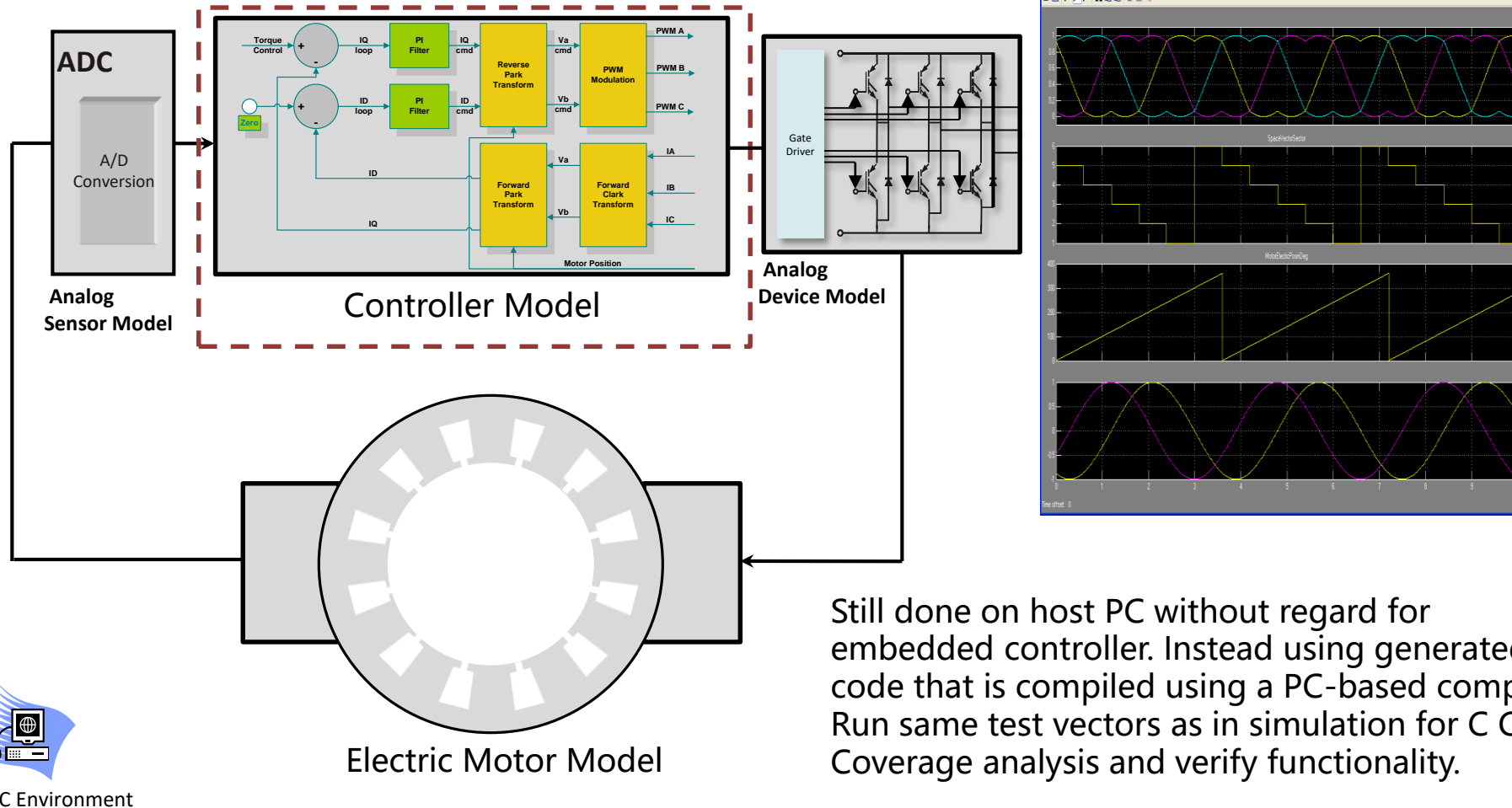

Still done on host PC without regard for embedded controller. Instead using generated C code that is compiled using a PC-based compiler. Run same test vectors as in simulation for C Code Coverage analysis and verify functionality.

# Model Based Design Steps: Step 3 (PIL)

**(PIL) Executes generated code on the target MCU**

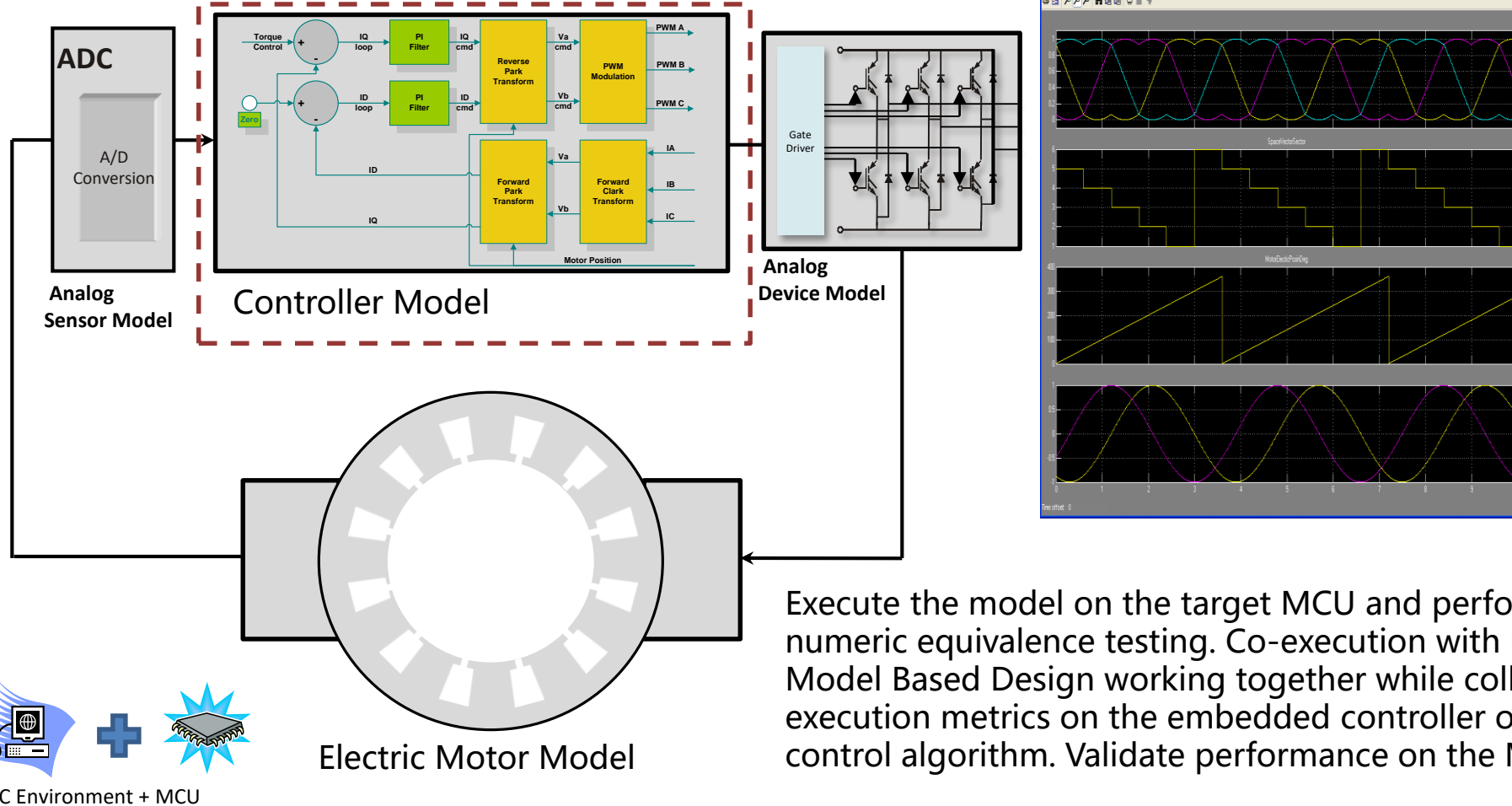

Execute the model on the target MCU and perform numeric equivalence testing. Co-execution with MCU and Model Based Design working together while collecting execution metrics on the embedded controller of the control algorithm. Validate performance on the MCU.

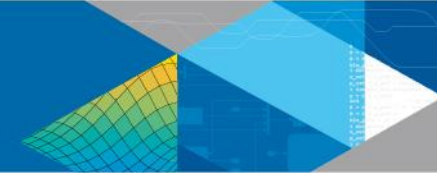

## Model Based Design Steps: Step 3 (PIL)

### Verification and Validation at Code Level

- This step allows:
  - ❖ Translation validation through systematic testing
  - ❖ To demonstrate that the execution semantics of the model are being preserved during code generation, compilation, and linking with the target MCU and compiler
- Numerical Equivalence Testing:
  - ❖ Equivalence Test Vector Generation
  - ❖ Equivalence Test Execution
  - ❖ Signal Comparison

# Example IEC 61508 and ISO 26262 Workflow for Model-Based Design with MathWorks Products\*

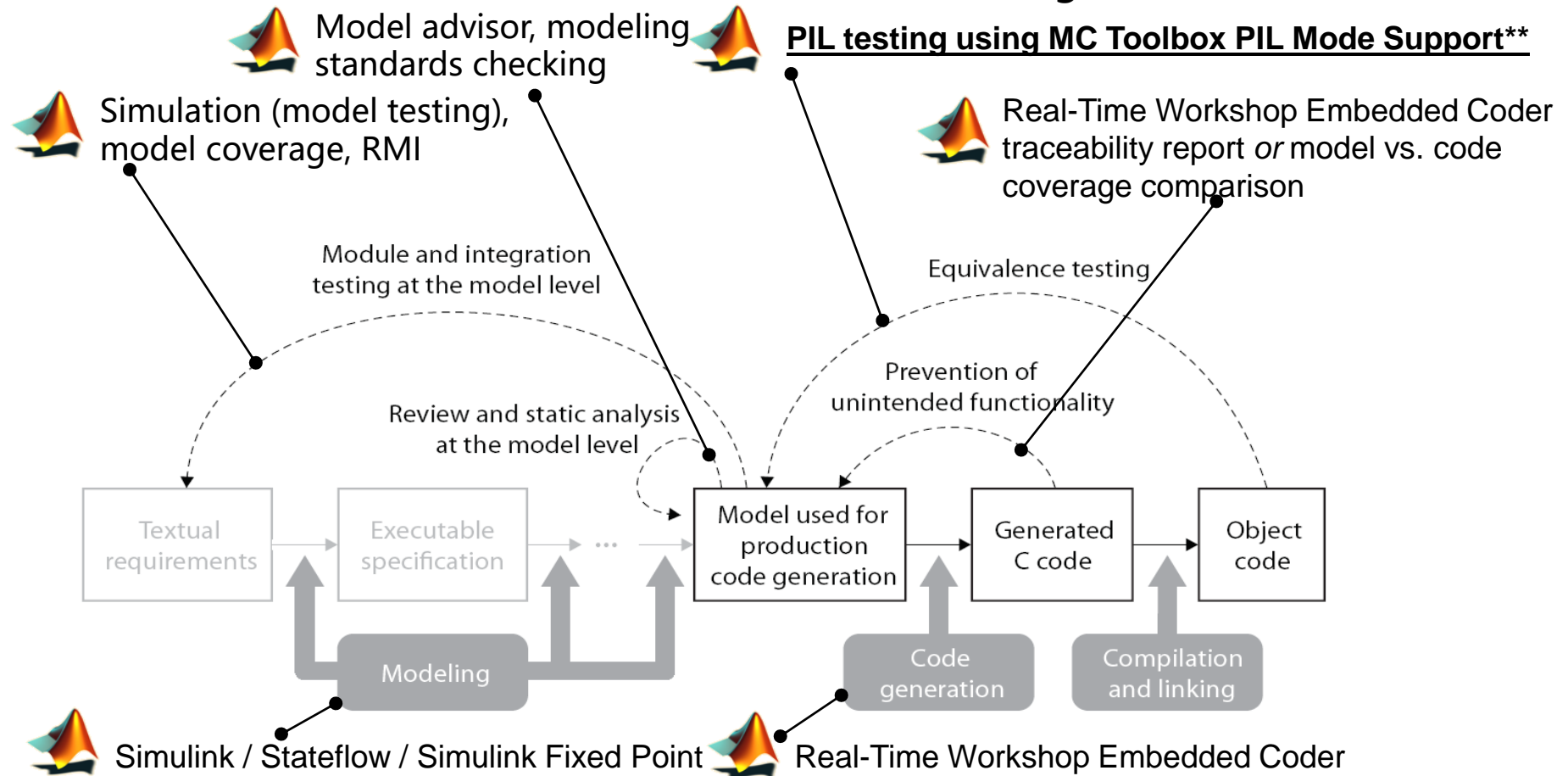

\*Workflow from The Mathworks™ Presentation Material Model-Based Design for IEC 61508 and ISO 26262

\*\* NXP MC Toolbox is part of Mathworks Workflow outlined in The Mathworks™ Material Model-Based Design for IEC 61508 and ISO 26262 as well as part of certification qualification tool suite.

# Model Based Design Steps: Step 4 (Target MCU)\*

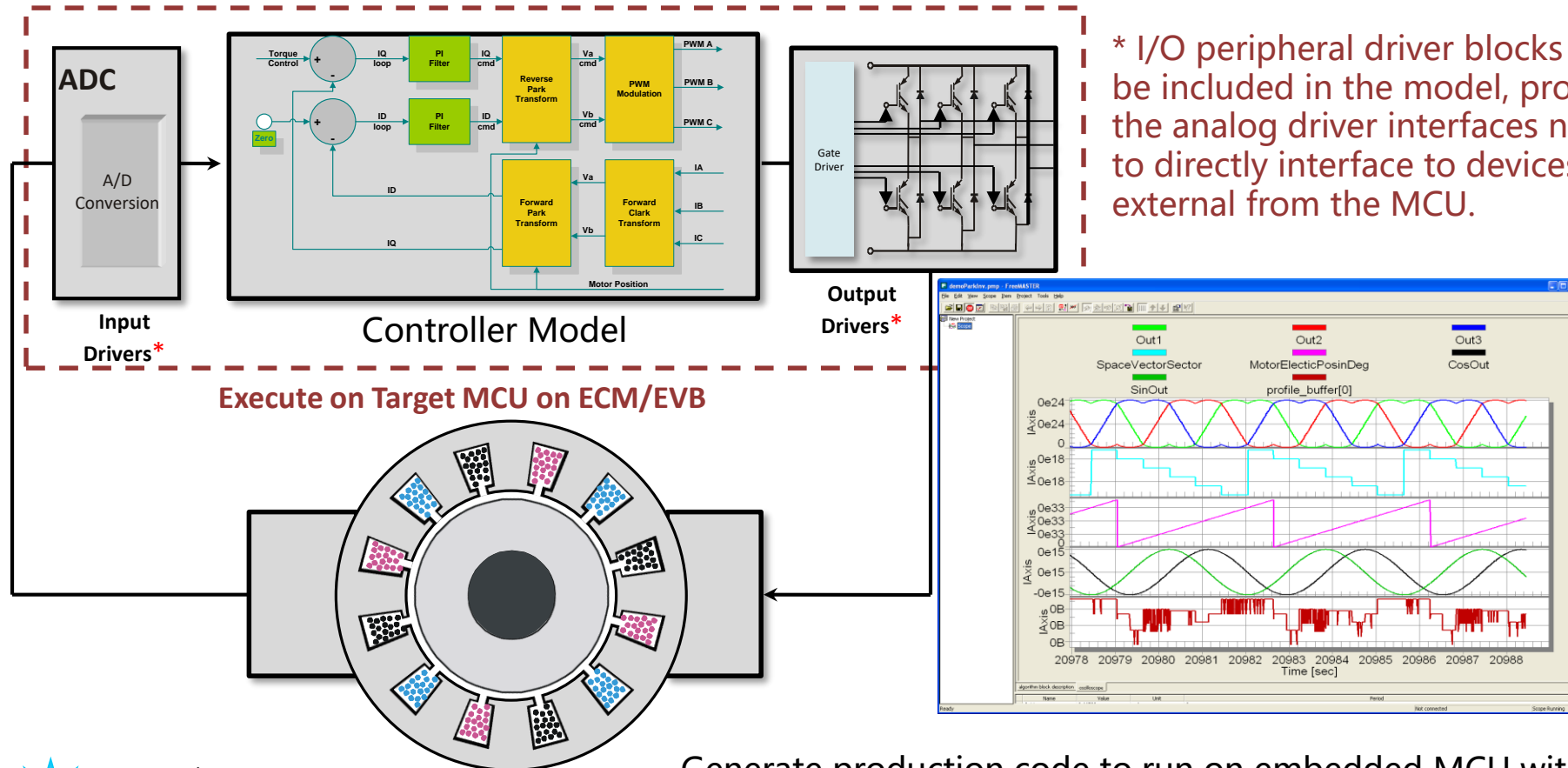

\* I/O peripheral driver blocks can be included in the model, providing the analog driver interfaces needed to directly interface to devices external from the MCU.

Execute on Target MCU on ECM/EVB



MCU with Embedded Control Module (ECM)

Electric Motor

Generate production code to run on embedded MCU with real motor while collecting execution metrics on the embedded controller of control algorithm. Validate performance on MCU and use FreeMASTER to tune control parameters and perform data logging.

# Model Based Design Steps: Summary

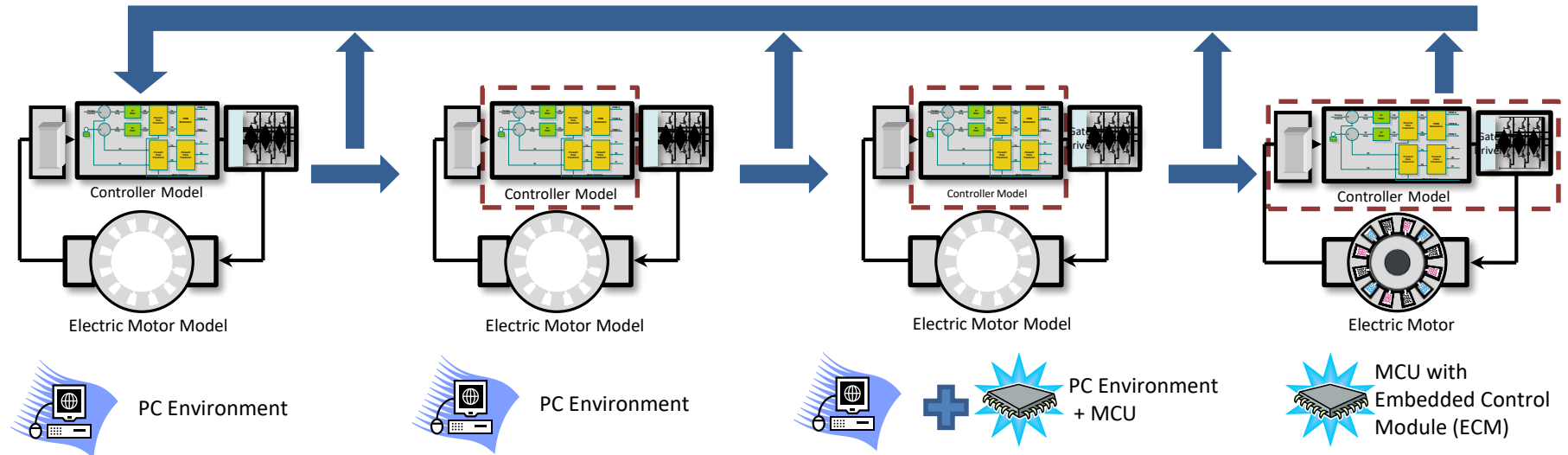

**Step 1 — System Requirements:**  
 MBD Simulation Only  
 Software requirements  
 Control system requirements  
 Overall application control strategy

[Modeling style guidelines applied](#)  
[Algorithm functional partitioning](#)  
[Interfaces are defined here](#)

**Step 2 — Modeling/Simulation:**  
 MBD Simulation with ANSI C Code using SIL  
 Control algorithm design  
 Code generation preparation  
 Control system design  
 Overall application control strategy design  
 Start testing implementation approach

[Testing of functional components of algorithm](#)  
[Test harness to validate all requirements](#)  
[Test coverage of model here](#)  
[Creates functional baseline of model](#)

**Step 3 — Rapid Prototype:**  
 MBD Simulation with ANSI C Code using PIL  
 Controller code generation  
 Determine execution time on MCU  
 Verify algorithm on MCU  
 See memory/stack usage on MCU  
 Start testing implementation approach  
 Target testing controls algorithm on MCU

[Refine model for code generation](#)  
[Function/File partitioning](#)  
[Data typing to target environment done here](#)  
[Scaling for fixed point simulation and code gen](#)  
[Testing of functional components of algorithm](#)  
[Test harness to validate all requirements](#)  
[Test coverage of model here](#)  
[Creates functional baseline of model](#)  
[Equivalence testing](#)

**Step 4 — Target MCU Implementation**  
 ANSI C Code Running on Target Hardware and MCU  
 Validation/verification phase  
 Controller code generation  
 Determine execution time on MCU  
 Start testing implementation on target ECM  
 Code generate control algorithm + I/O drivers. Complete implementation on ECM.  
 Test system in target environment Utilize calibration tools for data logging and parameter tuning

[Execute code on target MCU](#)  
[Functional testing in target environment](#)  
[Ensure execution on target is correct as well as code generation on target is performing as desired.](#)



## How to get it and where to find support

- Download MBD Toolbox: [www.nxp.com/mctoolbox](http://www.nxp.com/mctoolbox)
- MATLAB: [www.mathworks.com](http://www.mathworks.com)
- Support: <https://community.nxp.com/community/mbdt>

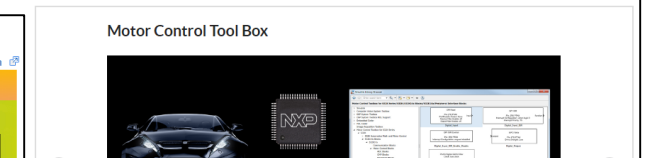
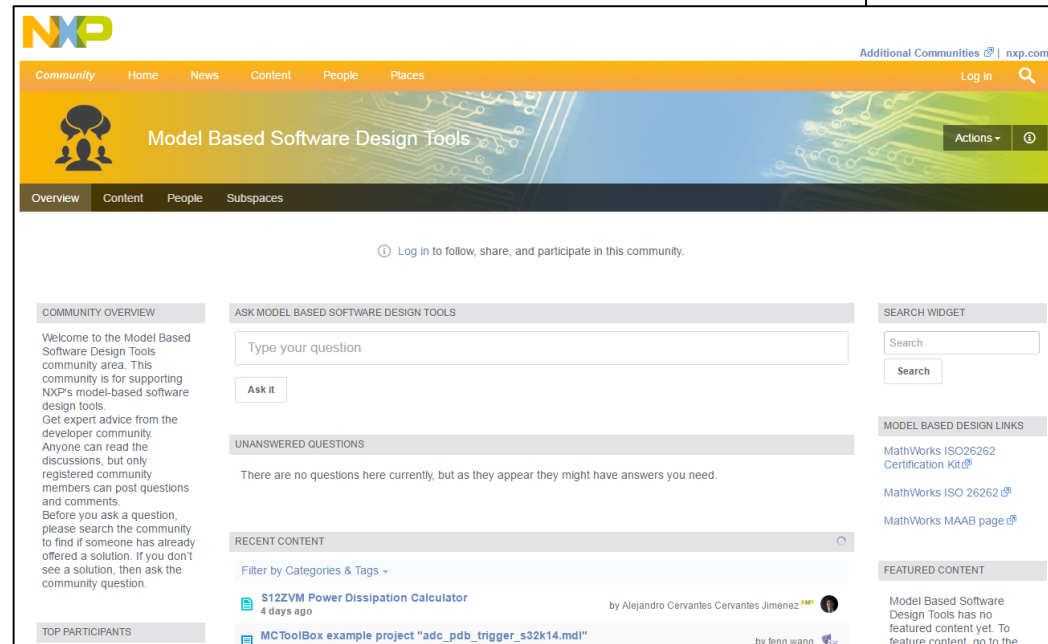
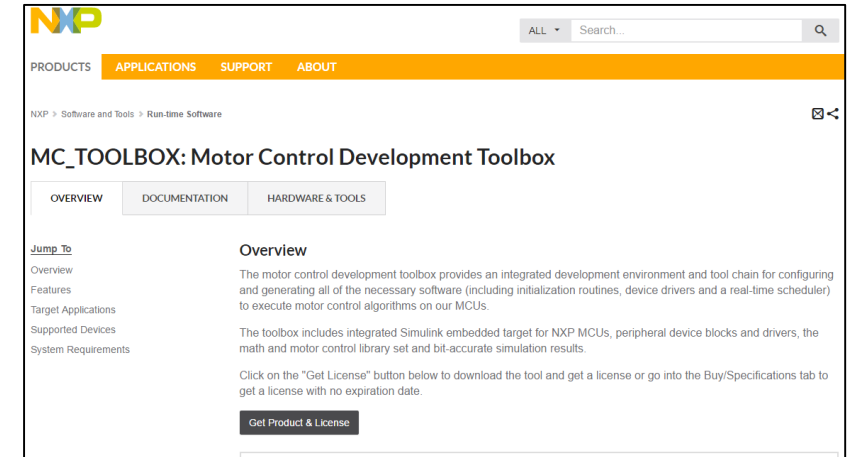



# Thank you